

MIVOICE OFFICE 400 MITEL 6867 SIP / MITEL 6869 SIP

USER GUIDE



Welcome...

Welcome to the user's guide for the desk phones Mitel 6867 SIP and Mitel 6869 SIP for MiVoice Office 400 communication systems.

This user's guide will assist you with the use of your phone and introduce you step by step to the functions and configuration. If you require further technical support or information on other Mitel products, please refer to our webpages www.mitel.com or our [Mitel DocFinder](#).

This user's guide is relevant only for Mitel SIP phones connected to a MiVoice Office 400 communication system. Other user's guides are available for operation on other communication systems or for direct operation via a SIP provider. Consult your system administrator if you are unsure whether you have the correct user's guide for your requirements.

- Notes:**
- Not all listed functions are available by default. Contact your system administrator to learn more about the available features and services in the MiVoice Office 400 communication system.
 - Your system administrator has the option to individually set some of the phone's features. In this case your default values will differ from the default values described in this user's guide.
 - Some functions are offered both from the MiVoice Office 400 communication system and locally from your Mitel SIP phone. Since the MiVoice Office 400 communication system does not completely support the local functions we recommend making your system administrator do the configuration or using the Self Service Portal (see chapter "[MiVoice Office 400 Self Service Portal](#)", Seite 8).

Safety information

Failure to observe this information can be hazardous and infringe existing laws.



Connections

Always plug the phone cable connectors into the appropriate sockets. Do not modify the connections in any way.



Power supply

Your phone can be supplied with power in various ways. Pay attention to the information given by the system administrator.

Note: The device will be inoperable when mains power of the communication system fails.



Metal objects

Telephone receivers produce magnetic fields that can attract small metallic objects such as pins and staples. To avoid injury, do not place the handset where such objects can be picked up.



Maintenance

Make sure all installation and repair work is carried out by a specially qualified technician.

Always use a soft, moistened, or antistatic cloth to clean your device. Do not use chemicals or other chemical products.



Cost control and Data protection

You should protect your phone with a PIN so that no-one can make phone calls at your expense. A code will also protect your personal settings.



Ambient conditions

Do not operate the device outside the temperature range of +5 °C to approx. +40 °C. Avoid direct sunlight and other sources of heat. Protect your device against the wet, excessive dust, corrosive liquids and steam.



Do not expose your device to electromagnetic fields (electric motors, household appliances). The speech quality could be affected.



Disposal

Be sure to dispose of your device, batteries and its packaging in an environmentally compatible way. Electrical equipment does not belong in domestic waste. Deposit it at a return centre.



Accessories

Use original accessories or specifically approved accessories only. The use of other accessories may decrease performance or pose a risk to your health or safety.

Welcome...

Document information

Document designation

- Document number: eud-1664
- Document version: 1.1
- Based on MiVoice Office 400 R4.0
- Valid as of MiVoice Office 400 R4.0
- In PDF Viewer, click on this link to download the latest version of this document:
https://pbxweb.aastra.com/doc_finder/DocFinder/eud-1664_en.pdf?get&DNR=eud-1664
- Copyright © 07.2015 Mitel Networks Corporation

Content

Welcome.....	2
Safety information.....	3
Document information	4
Information as to the MiVoice Office 400 communication system	7
Keys, display and menu guidance	9
Key designations and sockets	10
Display symbols	15
Operating your phone.....	17
Using expansion key modules	22
Using labels	28
Phoning	29
Making calls	30
Initiating calls	32
Using functions before/while in a call	38
Using further functions	51
Overview of available functions	56
Organising absences from the desk.....	61
Operating call lists and voice messages	65
Organisation within the team (busy lamp field).....	67
Line key on a key telephone.....	69
Using functions with OpenCount	71
Setting functions by remote control	72
Personalizing your phone	73
Configuring the display	74
Configuring the audio properties	75
Configuring general phone settings	77
Protecting yourself against calls.....	81
Phone book management	81
Configuring voice mail	82
Configuring presence profile.....	84
Configuring keys.....	86

Product and safety information	90
Safety information	91
Product information	91
Data protection	93
Limited Warranty (Australia only)	93
Index	97

Information as to the MiVoice Office 400 communication system

One number user concept

Your system administrator can set up several phones for you that hold all the same phone number (one number user concept). You have only one name and phone number with which to identify yourself to your call partners, regardless of which of the phone you make your calls. The advantage is that you can always be reached under the same phone number, regardless of where you happen to be.

With personal call routing you can define where incoming calls shall be routed to (see chapter "Activating personal call routing", Seite 51).

More benefits of the one number user concept

- You can determine the phone on which a call is acoustically signalled, with Ring Alone (see "Activating ring alone", Seite 52).
- Your system administrator can set whether or not you are busy for further incoming calls (busy if busy).
- You are still able to make further outgoing calls with the other terminals.
- Call lists and contacts stored on the MiVoice Office 400 communication system are available on all your phones and are automatically synchronised.
- An announcement will be indicated on all phones which support announcements.
- Fast take (*88) allows you to take a call from one phone on another.

MiVoice Office 400 Self Service Portal

The Self Service Portal is a web-based application for phones on a MiVoice Office 400 communication system. The Self Service Portal helps you configure and adapt your personal phone settings (i.e. key configuration, labels for configurable keys, display language, etc.) directly and autonomously on your PC.

As soon as you receive an user account for the Self Service Portal from your assistant manager and after you have logged in, you are taken to the home page with the overview of all your phones. Refer to the Self Service Portal online help for further information on a specific topic.

Contact your system administrator to access to the Self Service Portal.

Keys, display and menu guidance

The sections below provide an overview and usage on which keys and sockets are available on your phone.

Key designations and sockets.	10
Display symbols.	15
Operating your phone	17
Using expansion key modules.	22
Using labels.	28

Key designations and sockets

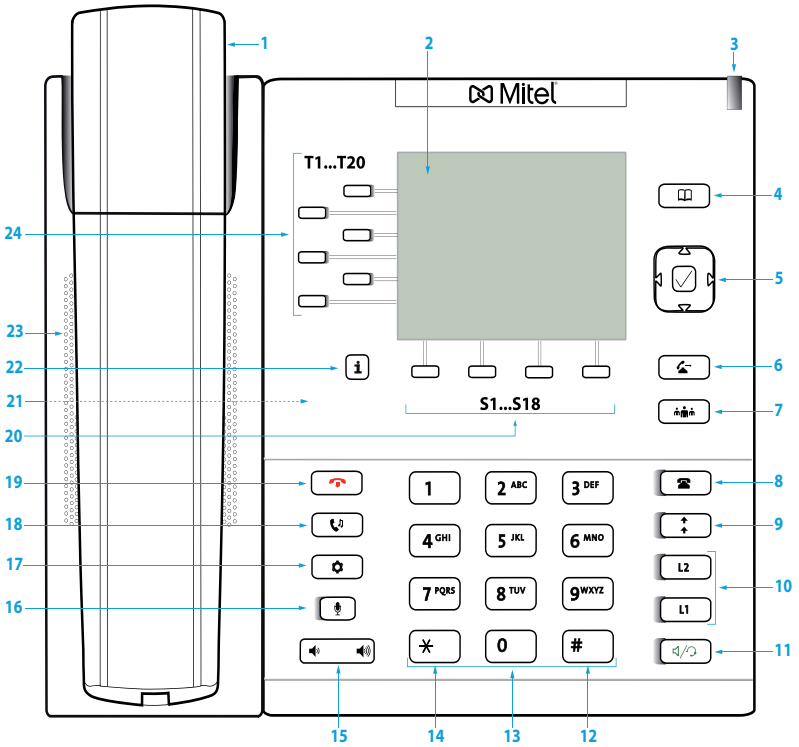





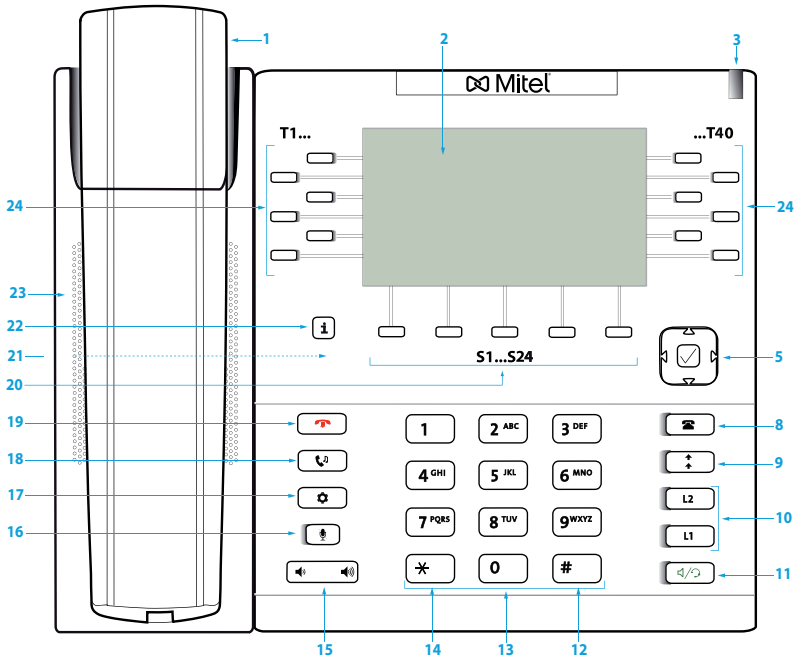





Mitel 6867 SIP











Keys, display and menu guidance





Mitel 6869 SIP

Keys, display and menu guidance

No.	Key	Description
1	Handset	
2	Display	Colour screen: <ul style="list-style-type: none"> • top left: line number, name • top right: status display (display symbols) • bottom right status notifications • Middle: Display, depending on phone status
3	 Message LED	Colour and status signal a specific event.
4	 Phone book key (Mitel 6867 SIP only)	Calling up the directory lookup
5	 Navigation key with selection key	
	 Horizontal navigation keys	<ul style="list-style-type: none"> • Switching between the display in idle state and line selection • Navigating in the options list
	 Vertical navigation keys	Navigating in the sub-menus of the options list
	 Selection key	<ul style="list-style-type: none"> • Selecting a menu item • Confirming settings
6	 Deflect key (Mitel 6867 SIP only)	Transferring a call
7	 Conference key (Mitel 6867 SIP only)	Setting up conference calls
8	 Call lists key	Calling up the call list menu: <ul style="list-style-type: none"> • unanswered • answered • Redial list
9	 Redial key	Using the phone number last dialled
10	 Line keys L1 to L2 with LED	<p>Mitel 6867 SIP: 2 line keys. A total of 9 lines are available.</p> <p>Mitel 6869 SIP: 2 line keys. A total of 12 lines are available.</p> <ul style="list-style-type: none"> • Seizing a line • Answering a call • Brokering with simultaneous configuration of multiple line keys

No.	Key	Description
11	 Loudspeaker/headset key with LED	<ul style="list-style-type: none"> • Activating/deactivating open listening • Activating/deactivating handset microphone • Activating/deactivating headset microphone
12	 Hash key	Entering # or special characters
13	 Digit keys 1-9	Entering characters and digits
14	 Asterisk key	Entering * or space
15	 Volume key	Adjusting the volume
16	 Microphone key with LED	<ul style="list-style-type: none"> • Activating/deactivating hands-free mode • Activating/deactivating handset microphone • Activating/deactivating headset microphone
17	 Option key	Calling up a local setting menu (options list)
18	 Hold key	<ul style="list-style-type: none"> • Holding an active call • Taking back a call from hold
19	 End key	<ul style="list-style-type: none"> • Ending a call • Back to display in idle state • Exiting editor without changes
20	 Bottom softkeys S1-S18 (Mitel 6867 SIP)	4 free configurable keys that can be configured with a total of 18 functions or call numbers, or which are automatically configured by the MiVoice Office 400 communication system with context-dependent functions.
	 Bottom softkeys S1-S24 (Mitel 6869 SIP)	5 free configurable keys that can be configured with a total of 24 functions or call numbers, or which are automatically configured by the MiVoice Office 400 communication system with context-dependent functions.

Keys, display and menu guidance













No.	Key	Description
21	Rear: <ul style="list-style-type: none">• Connection for expansion key module• Connection for power supply• Connection for USB 2.0• GigE dual connection for PC and LAN• Connection for headset• Combined four-pin module connection with DHSG/EHS headset connection¹⁾• Connection for Power-over-Ethernet, class 2 (Mitel 6867 SIP only)• Connection for Power-over-Ethernet, class 3 (Mitel 6869 SIP only)• Connection for wall mounting• Connection for magnetic keyboard	
22	 Info key	Accessing the phone status of a contact on the busy lamp field (see " Using the busy lamp field key ", page 67)
23	Speaker	
24	 Left softkeys T1-T20 with LED (Mitel 6867 SIP)	6 free configurable keys that can be configured with a total of 20 functions, call numbers or busy lamp fields. An LED is located next to each function key signalling the functional state.
	 Left/right softkeys T1-T40 with LED (Mitel 6869 SIP)	12 free configurable keys that can be configured with a total of 40 functions, call numbers or busy lamp fields. An LED is located next to each function key signalling the functional state.

¹⁾ Use the headset connection for headsets only. Connecting another device may cause damage to your phone and void your warranty.



Note: The Mitel 6867 SIP and Mitel 6869 SIP phones have removable key caps. If you change the position of a function on your phone, you can change the function to the corresponding function key using the Self Service Portal. An overview of the interchangeable functions can be found in the chapter "[Available keys](#)", page 86.

Display symbols

Call connection states, info

-  Incoming call
-  Connection set up
-  Call on hold
-  Mitel Hi-Q™ audio technology
-  Missed calls
-  New voice message (incl. number)
-  Voice message listened
-  Call forwarding activated
-  Phone locked
-  Do not disturb (if busy)
-  Record
- 
 - Data/voice encryption
 - Voice Mail mode: Recording not allowed
-  Voice Mail mode: Recording allowed

Option key

-  Language
-  Status
-  Time and Date
 - Settings
 - Time zone
 - Set date/time

Keys, display and menu guidance

Option key



Lock



- Password



- Phone lock



Audio



- Audio mode



- Headset



- Ring Tones



- Tone set



Display



Restart



Dialpad



- Speeddial

Presence state



Available (default)



Meeting



Absent



Busy



Not available

Operating your phone

Most keys and functions are described in the key legend. Other overviews and operating aids can also be found here.

Overview system menu

Access to the system menu is made using the *Menu*. This contains the following menu entries. Refer to the relevant chapters of this user's guide for further information on these menu entries.

MiVoice Office 400 System men

1. *Call list* (depends on settings in the MiVoice Office 400 communication system)
2. *Directory Lookup*
3. *Voice Mail*
4. *Forwarding*
5. *Presence*
6. *Call routing*
7. *Alarm melodies*
8. *Information*

Using the softkey/navigation key

Softkeys are the keys that are automatically configured with context-dependent functions by the MiVoice Office 400 communications system. The functions are displayed above the softkeys. The softkeys are configured with the most commonly used functions, whereby the left softkey is always the *Back* key and the right softkey is always the More key () when more than four softkeys are configured. The More key is needed to switch between the key levels. The number of points indicates the number of levels.

A menu can have several sub-menus. Press the suggested softkey or selection key to access the sub-menu or the selection of possible editing options, or to carry out the action.

Free configurable keys

Your phone is equipped with freely configurable keys. Popular functions are set up on a specific configurable key as standard by your system administrator (see chapter ["Overview function key configuration \(default key setting\)", page 18](#)). The remaining configurable keys can be configured with a specific action type: Call number, function, busy lamp field. A busy lamp field can only be saved on function keys T1 to T20 (Mitel 6867 SIP) or function keys T1 to T40 (Mitel 6869 SIP).

The key configuration is not made directly on the phone. Available settings for the key configuration:

- **MiVoice Office 400 communication system:** The configuration has already been made by your system administrator in the communication system.
- **Self Service Portal:** You can use the Self Service Portal (see chapter ["MiVoice Office 400 Self Service Portal", page 8](#)) where you can configure, change or delete the keys however you wish.

More information on the configurable keys can be found in the chapter ["Configuring keys", page 86](#).

Overview function key configuration (default key setting)

Mitel 6867 SIP/Mitel 6869 SIP phones on the MiVoice Office 400 communication system are delivered with the following function key configuration. Please note that your system administrator may change this and your phone may therefore differ from this default configuration.

Function key	Mitel 6867 SIP	Mitel 6867 SIP if logged in as free seating phone
Key T1-T20	Empty ¹⁾	Empty ¹⁾
Key S1	System menu	System menu
Key S2	Voice mail menu	Free seating: Log in/out
Key S3	Call forwarding menu	Request a callback
Key S4	Take (pick up own call)	Empty ¹⁾
Key P5	Call routing menu	Empty ¹⁾
Key S6	Phone lock on/off	Empty ¹⁾
Key S7	Request a callback	Empty ¹⁾
Key S8-S18	Empty ¹⁾	Empty ¹⁾

¹⁾ The key assignment is configured with an empty function.

Function key	Mitel 6869 SIP	Mitel 6869 SIP if logged in as free seating phone
Key T1-T20	Empty ¹⁾	Empty ¹⁾
Key S1	System menu	System menu
Key S2	Phone book: System	Free seating: Log in/out
Key S3	Voice mail menu	Request a callback
Key S4	Call forwarding menu	Empty ¹⁾
Key P5	Take (pick up own call)	Empty ¹⁾
Key S6	Call routing menu	Empty ¹⁾
Key S7	Phone lock on/off	Empty ¹⁾
Key S8	Request a callback	Empty ¹⁾
Key S9-S18	Empty ¹⁾	Empty ¹⁾

¹⁾ The key assignment is configured with an empty function.





Overview alphanumeric keyboard

The alphanumeric keyboard can be used for entering digits and the password, for entering text and special characters, and also for quickdial. Press the relevant key repeatedly until the character you want is displayed.

The alphanumeric keyboard is configured with the characters from the following table. Please note that the actual character selection is dependent on the selected language.

	Upper case	Lower case
1	1 . : ; = _ , - ' & ()	
2 <small>ABC</small>	A B C 2 Ä Á À Ã Ä Æ Å Ç A B V G	a b c 2 ä á à å æ å ç a b v g
3 <small>DEF</small>	D E F 3 É Ê Ë Д Е Ё Ж Э	d e f 3 é ê ë д е ё ж э
4 <small>GHI</small>	G H I 4 Í Î Ï Й К Л	g h i 4 í î ï й к л
5 <small>JKL</small>	J K L 5 M H O П	j k l 5 m h o п
6 <small>MNO</small>	M N O 6 Ñ Ö Ó Ô Õ Ö Ø P R S T Y	m n o 6 ñ ö ó ô õ ö ø p r s t y
7 <small>PQRS</small>	P Q R S 7 В Ф Х Ц Ч	p q r s 7 в ф х ц ч

Keys, display and menu guidance

	Upper case	Lower case
	T U V 8 Ü Ú Û Ů Ш Щ Ъ Ы	t u v 8 ü ú û ů ш щ ъ ы
	W X Y Z 9 Ъ Ы З Ю Я	w x y z 9 ъ ы з ю я
	0 +	
	* <Space>	
	# / \ @ \$	

Entering text

Entering digits and letters: In text mode, you can switch between digit and letter input using the *abc / ABC / 123* softkey.

Correcting entries: To delete an incorrect character, use the *Backspace* softkey.



Confirming entries: An entry or selection can be confirmed using the *Selection* or *Select* softkey.

Closing the editor without saving: With the *Back* softkey or the done key, you can cancel the entry without saving or go back to the idle state in the menu.





LED overview

The attention LED and LED in the function / line key signal different events and operating states with different colours and light statuses.



Message LED:

State	Description
	<ul style="list-style-type: none">Incoming callAppointment call
	New voice message
	Phone locked

LED in line key:

State	Description
 Does not light up	Line free
 Flashes fast	<ul style="list-style-type: none"> • Incoming call • Appointment call
 Flashes slowly	Call party on hold. Call be answered on any phone.
 Lit	Connected

LED function key or busy lamp field key:

State	Description
 Does not light up	<ul style="list-style-type: none"> • Function is deactivated • User free (busy lamp field)
 Flashes fast	User is being called (Busy lamp field)
 Lit	<ul style="list-style-type: none"> • Function is activated • User busy (busy lamp field)

Call lists key:

State	Description
 Lit	Missed calls

Using expansion key modules

The connection of expansion key modules to your phone gives you additional, freely configurable keys.

Expansion key module Mitel M680

You can connect up to three Mitel M680 expansion key modules next to each other on your phone. The Mitel M680 has the following properties:



- 16 configurable keys. Three expansion key modules would then give you an additional 48 configurable keys.
- Each key has an LED for visual signalling.
- The keys on the expansion key module support all key types that are supported by your phone's keys.
- The configurable keys of the expansion key module can be operated as the configurable keys of your phone.
- Keys must be configured by your system administrator or by yourself in the Self Service Portal (see ["MiVoice Office 400 Self Service Portal", page 8](#)).
- Labels for key identification (see chapter ["Using labels", page 28](#)).



Expansion key module Mitel M685

You can connect up to three Mitel M685 expansion key modules on your phone. The Mitel M685 has the following properties:

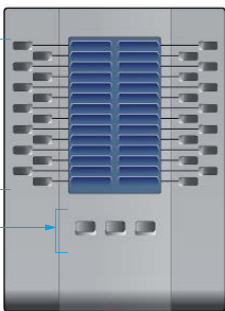
- Coloured touchscreen
- 3 key levels of 28 configurable keys each (84 configurable keys in total). Three Mitel M685 would therefore give you an additional 252 configurable keys.
- Each key has an LED for visual signalling.
- The keys on the expansion key module support all key types that are supported by your phone's keys.
- The configurable keys of the expansion key module can be operated as the configurable keys of your phone.
- Keys must be configured by your system administrator or by yourself in the Self Service Portal (see "[MiVoice Office 400 Self Service Portal](#)", page 8).
- If you remove an expansion key module or if you modify the order of the connected expansion key modules, the key configuration does not change.
- The display contrast setting and the display backlight is taken from your phone.

No.	Key	Description
1		<p>A1-A84 function keys (3 key levels, 28 keys each)</p> <p>Freely configurable keys. An LED is located next to each function key signalling the functional state.</p>
2		<p>Function key for level 1, 2, 3</p> <p>Call up the desired level.</p>

Keypad Mitel K680

You can connect a magnetic keypad to your phone in order to simplify text input. The Mitel K680 has the following properties:

- The keyboard can be connected and removed magnetically.
- The keyboard connection is available in three versions:
 - QWERTY (Mitel K680 QY),
 - QWERTZ (Mitel K680 QZ),
 - AZERTY (Mitel K680 AY).
- The phone supplies power to the keyboard.

Note: Mitel K680 settings in the menu are only available if a Mitel K680 is connected.



Pressing a letter on Mitel K680:

Press any letter.

→Directory Lookup is now activated.



Pressing digits on Mitel K680:

Press any digit.

→Call preparation is now activated.



Activating/deactivating Directory Lookup with Mitel K680:

Press the option key.



Scroll to *Phone book* and press the selection key.



Scroll to *Keypad search* and activate/deactivate the keypad search.

Mitel K680 QWERTY



1	Tab key
2	Caps lock
3	Shift key
4	Navigation keys
5	Space key
6	Enter key
7	Del (backspace)

Keys, display and menu guidance

Mitel K680 QWERTZ



1	Tab key
2	Caps lock
3	Shift key
4	Navigation keys
5	Space key
6	Alt key
7	Enter key
8	Del (backspace)

Mitel K680 AZERTY



- | | |
|---|------------------------|
| 1 | Tab key |
| 2 | Caps lock |
| 3 | Shift key |
| 4 | Navigation keys |
| 5 | Space key |
| 6 | Alt key |
| 7 | Enter key |
| 8 | Del (backspace) |

Note: To enter numbers, press Shift + Number.

Using labels

Printing and attaching the labels

Labels can be created and printed using the Self Service Portal (see chapter "MiVoice Office 400 Self Service Portal", page 8).

Mitel M680:

1. Label and print the write-on labels over the Self Service Portal (important printer setting: "Page scaling for printing: None").
2. Cut out the labels according to the crop marks.
3. Remove the cover and insert the label into the recess.
4. Re-insert the cover into the recesses on the keypad.

Phoning

The following sections explain the supplementary features provided by your phone for more efficient use.

Making calls	30
Initiating calls	32
Using functions before/while in a call	38
Using further functions.	51
Overview of available functions	56
Organising absences from the desk	61
Operating call lists and voice messages	65
Organisation within the team (busy lamp field)	67
Line key on a key telephone	69
Using functions with OpenCount	71
Setting functions by remote control	72

Making calls

This section explains how to set your calls.

Answering, ending or rejecting a call

Answering calls: The phone rings and the message LED and line key LED flash. If the caller's phone number is received, it is shown on the display. If the phone number is stored in the private phone book or in the MiVoice Office 400 communication system, the display also shows the corresponding name.

Open listening: With the open listening mode function, the loudspeaker is activated in addition to the handset so that other people in the room can listen to the call. You can continue with the call as usual using the handset.

Rejecting calls: As long as you have not picked up a call, you can reject it during the ringing phase.



Answering a call with the handset:

Pick up the handset.



Answer a call with the line key

Press the line key and pick up the handset.



Answering a call with the softkey

Press the *Answer* softkey and pick up the handset.



Open listening during a call:

Activate: Press the Loudspeaker key.

Deactivate: Press the Loudspeaker key a second time.



Ending a call in open listening mode:

Press the Loudspeaker key and pick up the handset.

Note:

If you merely replace the handset, the phone switches to the hands-free mode.



Ending a call:

Put the handset on-hook or press the End key.



Rejecting a call:

Press the End key or the *Ignore* softkey during the ringing phase.

→ The connection is rejected and, depending on the system configuration, the caller either hears the busy tone or is forwarded to a preconfigured destination.

Using your phone in hands-free mode

You want other people to join the conversation or to have your hands free while making the call.

The handsfree mode function activates the loudspeaker and the microphone. Make sure the hands-free microphone is not obstructed. The sound quality is improved if you set the volume of your phone to a low setting.



Answering/ending a call in handsfree mode:

Answer: Press the loudspeaker or the line key.

End: Press the End key.



Handsfree during a call:

1. Press the Loudspeaker key.
→ Open listening is activated.
2. Put the handset on-hook.
→ Handsfree is activated.



To continue the call with the handset:

Pick up the handset.

→ The loudspeaker and hands-free microphone are now deactivated.



Ending a call:

Put the handset on-hook.

Muting the microphone

In the middle of a call you want to talk briefly with other persons in the room without your call partner hearing your conversation.

You can switch the microphone on and off during a call, regardless of whether you are using the handset, headset or handsfree system.



Switching the microphone on and off during a call:

Activate: Press Microphone key.

Deactivate: Press the Microphone key once again.

→ Microphone is activated/deactivated, the LED on the Microphone key flashes/does not flash.

Using a headset

To make a phone call with the headset.

If you answer a call in headset mode using the Loudspeaker key, the call is provided on the headset. Alternatively you can also answer the call by picking up the handset.

All the headset mode configuration possibilities can be found in chapter "[Setting the audio properties](#)", page 76. Further information can be found in the user's guide for your headset.



Answering a call with the headset:

Press the key on the headset or the Loudspeaker key.



Ending a call with the headset:

Press the key on the headset or the Loudspeaker key.

Initiating calls

This section explains some convenient features provided by your phone for making a call.

Dialling with the phone number

You want to call someone and key in that person's phone number.

With call preparation you can enter a phone number without it being dialled automatically, so you have time to check the number and, if necessary, correct it. The number is not dialled until you go off-hook, for example by picking up the handset.



Dialling with the phone number:

Enter a phone number in call preparation.

Incorrectly entered characters can be deleted using the [Back](#) softkey or with the navigation key to the right.



Pick up the handset or press the [Dial](#) softkey.

Dialling from the phone book (directory lookup)

You want to make a call by entering a name.

With directory lookup, you can search for an contact in your private phone book, system phone book or a connected external phone book. The response time may vary depending on the size and the number of phone books connected. The following search options are available:

Menu	Description
<i>Quickdial</i>	With Quickdial you only need to press the digit keys for each letter once, even though each key is assigned several letters. An efficient algorithm provides quick search results.
<i>Dial by name</i>	Enter the corresponding letter for dialling by name. The surname and first name have to be separated by a space (*-key).
<i>Advanced search</i>	If you select <i>Advanced search</i> , you can search directly in the connected external phone books. This function is not available if no external phone book is connected. The surname, first name and town each have to be separated by a space (* key), for example "no s so" for Noble Stephen in Solothurn.

Tips for search input:

- Press each of the corresponding digit keys once for the first few letters of the name you are looking for. For each letter, the display shows the corresponding digit, for example a "6" for the letter "n".
- Ask your system administrator whether you should start with the surname or the first name.
- The search function is not affected by upper/lower case and special characters.
- To find out how to search using the Mitel K680 keypad, see chapter "[Keypad Mitel K680](#)", page 24.
- More information on the phone books can be found in the chapter "[Phone book management](#)", page 81.



Directory lookup:
Press the Phone book key.



Directory lookup:
Press the function key for *Menu*.

Phoning



Scroll to *Directory Lookup* and press the navigation key to the right.



Directory lookup with quickdial: In the *Quickdial* field, enter the first few letters of the name you are looking for using the corresponding digits.

Directory lookup with dialling by name: In the *Dial by name* field, enter the first few letters of the name you are looking for.

Directory lookup with advanced search: In the *Advanced search* field, enter the first few letters of the name you are looking for and the town (each separated by a space).



Press the *Lookup* softkey.

→ Names list (or *List empty*, if the phone is unable to find a matching user) is displayed.



Scroll through the list and select the user you want.



Pick up the handset.

→ The phone number displayed is dialed.

Dialling from the call list

You want to call a user from one of the three call lists. You can choose from the following call lists:

Menu	Description
<i>Unanswered calls</i>	List of callers who tried to reach you when you were absent.
<i>Answered calls</i>	List of calls answered.
<i>Redial list</i>	List of calls made.

Missed calls are signalled on the display; the message LED in the call lists key shines red.

Your phone automatically stored the person's phone number and name in a call list in the MiVoice Office 400 communication system. Within the one number user concept (see chapter "[One number user concept](#)", page 7) you can call back users through one of these call lists. The individual call lists include a maximum of 30 entries per list. More information on call lists can be found in "[Editing options for the call list](#)", page 65.

The call lists can be operated via the call list key, the redial key, the system menu, or a function key (see "[Configuring keys](#)", page 86).



Call list for unanswered/answered calls:

Press the call list key.



Scroll to *Unanswered* or *Answered* and press the navigation key to the right.
→The display shows a list of the last unanswered/answered calls.



Scroll through the list until the user you want is displayed.



Pick up the handset.

→The call number of the user is dialled.

Note: Once the call has been successfully connected, the entry is deleted from the unanswered call list.



Redial list:

Press the Redial key.

→List of the last dialled entries is displayed.



To scroll through the call numbers last dialled, press the navigation key downwards.



Pick up the handset.

→The call number of the user is dialled.

Dialling with a configurable key

You want to call someone whose phone number is stored under a configurable key.

To find out how to configure a configurable key, refer to the chapter "Configuring keys", page 86.



Phoning with the handset:

1. Pick up the handset.
2. Press the desired configurable key.
→The phone number is dialled.



Using your phone in handsfree mode:

- Press the desired configurable key.
→The phone number is dialled.

Dialling with the line key

You want to make a call via a line key.

Mitel 6867 SIP: You can make a call via a line key. Your phone is equipped with two dedicated line keys with LED (L1, L2). Your system administrator can set up to seven additional line keys (making a total of nine). The actual number of line keys depends on the system configuration. Press a dedicated line key directly or select a line by pressing the horizontal navigation key to the right. The display will show the line number (L1, L2 etc.). If a line is free, then the *New call* softkey at the bottom left of the display can then be used.

Mitel 6869 SIP: You can make a call via a line key. Your phone is equipped with two dedicated line keys with LED (L1, L2). Your system administrator can set up to ten additional line keys (making a total of twelve). The actual number of line keys depends on the system configuration. Press a dedicated line key directly or select a line by pressing the horizontal navigation key to the right. The display will show the line number (L1, L2 etc.). If a line is free, then the *New call* softkey at the bottom left of the display can then be used.

You can switch the line by pressing the key. The active call is automatically put on hold locally.



Dialling with the line key:

Enter the phone number.

L1

Press a free line key.

→The phone number is dialled. The LED on the line key lights up.

L2

Holding the call and switching lines:

1. Press a second, free line key or select a new line key with the horizontal navigation key.

2. Enter the phone number.

→The call is held on line key 1 and the call on line key 2 is active.

Note: Press line key 1 to return again to the call party on line 1 (see also "Brokering between an enquiry call party and your call partner", page 41).

Activating another Mitel phone for making calls

You want to make a call on another Mitel phone using your personal settings, for example on a colleague's phone or in a meeting room.

You can activate another Mitel phone to make an internal or external call using your personal settings, even if the phone is locked for external calls. You can activate the phone for a business or private call. Once you have activated the phone using a function code and your PIN, dialling by your private phone book is available. The called party's display shows your personal phone number and not the number of the phone from which you are making your call. Any call charges incurred will be charged to you.



Business calls:

1. Enter function code #36 for a business call.
2. Enter your internal phone number.
3. Enter your PIN.
4. Enter the internal or external phone number with the exchange access digit.



Pick up the handset.

→ The phone number displayed is dialled.

Note: When you hang up, dialling by name and your private phone book remain available for a whole minute so you can make another call.



Private calls:

1. Enter function code #46 for a private call.
2. Enter your internal phone number.
3. Enter your PIN.
4. Enter the external call number directly, without the exchange access digit.
5. Pick up the handset.

→ The phone is now enabled; the external user is called.

Note: The default PIN setting '0000' is not accepted (for more information on the PIN, see chapter "[Changing the PIN](#)", page 79).

Private call with PIN

You want to make a private call on your phone or on another Mitel phone.

With the aid of your PIN you can use any phone to make an external call with your own personal settings, even if that phone is locked for external calls. The called party's display shows your personal phone number and not the number of the phone from which you are making your call. Any call charges incurred will be charged to you. The call number dialled is not stored in the last-number redial list.



Private call with PIN:

1. Enter function code #46 followed by your internal call number.
2. Enter your PIN.
3. Enter the external call number directly, without the exchange access digit.



Pick up the handset.

→The phone is now enabled. The external user is called.

Note: The default PIN setting '0000' is not accepted (for more information on the PIN, see chapter "[Changing the PIN](#)", page 79).

Using functions before/while in a call

This section explains the special features provided by your phone before you make a (second) call or while you are in a call.

Requesting a callback

You want to talk to a certain person. The person is busy or does not answer. You can make callback requests to both internal and external users. Not all providers support this function.

If the called party is busy, you can activate an automatic callback. In this case, your phone will start ringing as soon as the party you are trying to reach goes on-hook. When you pick up the handset, the person you want to call is dialled directly. If the called party does not answer, you can also request a callback. The user then obtains a message indicating your callback request on his display.

This function must be saved to a configurable function key with Self Service Portal (see chapter "Configuring or deleting a key assignment", page 88).

- Notes:**
- You can activate only one callback at a time.
 - An unanswered callback request will automatically be cancelled by the system after about 30 minutes.



Activating callback:

You called someone and hear the busy tone or the ring-back tone. Press the function key for *Callback*.

→ Depending on the communication system you hear the acknowledgement tone.



Put the handset on-hook.

→ The display shows *Call expected*, LED of the function key is switched on.



Clear callback:

Press the function key for *Callback*.

→ Callback request is deleted.

To answer the callback request

Someone has asked you to call back. The display shows *Callback*.

You cannot automatically answer a callback request on your phone. You can either enter the call number manually or use a CTI client, for example the Mitel OfficeSuite.



Answering the callback request:

Enter a phone number in call preparation.



Pick up the handset or press the *Dial* softkey.

Note: You cannot delete a callback request.

Hide number

You do not want your call number to appear on the terminal display of a called party in the public network. The following options are available here:

Menu	Description
<i>Permanent</i>	The call number is never displayed.
<i>Per call</i>	Call number should only be restricted for certain calls. This function must be activated before dialling the call number.

This function must be saved to a configurable function key with Self Service Portal (see chapter "Configuring or deleting a key assignment", page 88).

- Notes:**
- Your call number can only be hidden if you select an external call number.
 - This feature depends on the range of services offered by your provider.



Activating/deactivating calling line identification restriction permanently:

Press the function key for *Hide number*.

→Function is activated/deactivated, LED on the function key is switched on/off.



Activating CLIR per call:

1. Press the function key for *Hide number*.

2. Enter the call number and press the *Select* softkey.

→Call number is dialled and your own number is not displayed to the called party.

Putting a call partner on hold

You want to briefly interrupt the active call.

You can put the call party on hold and then take them back again on the same phone.



Putting the active call party on hold:

Press the Hold key.

→The call party is put on hold,  is displayed and the LED on the line key flashes.



Take back the call party on hold:

Press the Hold key, the flashing line key or the *Pick up*.

→The call is active again.

Enquiry call during a call

You want to call someone else briefly without losing your current call partner. Then you want to resume your conversation with your original call partner.

With the Enquiry function you can call someone else in the middle of a call and put your original call partner on hold. You can make enquiry calls to both internal and external users.



L2

Setting up an enquiry call (you are in a call):

Press a free line key (select using the horizontal navigation key, if necessary, and confirm with the selection key).



Enter the call number of the enquiry partner and press the *Dial*.

→ Enquiry call party is called; first call partner is put on hold.

Notes:

- You can also set up an enquiry call by pressing the busy lamp field key to which you have saved the enquiry call party.
- If the other user does not answer, you can cancel the enquiry call with the *Cancel* softkey or with the End key and take back the first call with the flashing line key.



Ending the enquiry call:

Press the *Drop* or the End key.

L1

Retrieving the first parked call party:

Press the *Pick up* softkey or the flashing line key.

Brokering between an enquiry call party and your call partner

You are talking with an enquiry call party and have your first call partner on hold. You want to be able to switch back and forth between the two.

In an enquiry call you can use the brokering function to switch back and forth between an enquiry call party and the party on hold. Brokering is possible with both internal and external users. You can also broker between conference parties as a group and an enquiry call party.



L1

Brokering (to switch back and forth between the callers):

You are in an active call and have set up a connect to another call party with the Enquiry function.

Press the respective flashing line key or select the other call party with the horizontal navigation key.

→Your call partner changes. The other call party is put on hold.

Note: You can also broker by pressing the busy lamp field key to which you have saved the call party.



Terminating a call:

Press the *Drop* or the End key.

L1

Retrieving the first parked call party:

Press the *Pick up* softkey or the flashing line key.

Making a conference call

You want to make a conference call.

A conference call allows you to connect three call parties. From a conference call/call, you can initiate an enquiry call to someone else. You can broker between the conference participants and the enquiry call party.

Depending on the system configuration, a conference call can consist of up to 6 conference participants. You can hold a conference call with internal and external users.

Note: If you have a user account for the Self Service Portal, you can create conference rooms there (see ["MiVoice Office 400 Self Service Portal"](#), page 8).



Setting up a conference (you are connected):

1. Press the *Conference* softkey.
2. Enter the phone number of the conference call party.
3. Press the *Dial* softkey.
→The conference party answers the call.
4. Press the *Conference* softkey.

Notes:

- You can also set up a conference by pressing the busy lamp field keys to which you have saved the call party.
- You can change the procedure by first starting an enquiry call before you set up a conference.



Leaving a conference call:

Put the handset on-hook or press the End key.

→The other conference parties remain in the call.

Transferring a call

You want to put your call partner through to someone else.

With the call transfer function you can connect your call partner with someone else. You can connect internal and external users with one another. You can transfer the call with or without prior notice:

Menu	Description
Call transfer with prior notice	You only transfer the call after you have first talked to the second call party yourself.
Call transfer without prior notice	Without talking to the second call party, you transfer the call to them by hanging up the handset immediately after dialling the call number.



Mitel 6867 SIP:



Call transfer with prior notice (you are in a call):

1. Press the forward key.
2. Enter the call number of the second call party and press the **Select** (or press the corresponding busy lamp field).
 - The second call party is called; first call party is put on hold.
3. Wait until the person has answered the call.
 - If the other user does not answer, you can cancel the second call with the **Cancel** softkey or with the End key and take back the first call.
4. Announce the call party.
5. Put the handset on-hook.
 - Your first call partner and the other person are now connected with each other.



Call transfer without prior notice (you are in a call):

1. Press the forward key.
2. Enter the call number of the second call party and press the **Select** (or press the corresponding busy lamp field).
 - The second call party is called; first call party is put on hold.
3. Wait for the first ring tone.
4. Put the handset on-hook.
 - The other party is then called directly by your first call partner.
 - Recall: If the other party does not answer, the call comes back to your phone.

Note: You can change the procedure by first starting an enquiry call before call transfer.

Phoning

Mitel 6869 SIP:



Call transfer with prior notice (you are in a call):

1. Press the *Forward* softkey.
2. Enter the call number of the second call party and press the *Select* (or press the corresponding busy lamp field).
 - The second call party is called; first call party is put on hold.
3. Wait until the person has answered the call.
 - If the other user does not answer, you can cancel the second call with the *Cancel* softkey or with the End key and take back the first call.
4. Announce the call party.
5. Put the handset on-hook.
 - Your first call partner and the other person are now connected with each other.



Call transfer without prior notice (you are in a call):

1. Press the *Forward* softkey.
2. Enter the call number of the second call party and press the *Select* (or press the corresponding busy lamp field).
 - The second call party is called; first call party is put on hold.
3. Wait for the first ring tone.
4. Put the handset on-hook.
 - The other party is then called directly by your first call partner.
 - Recall: If the other party does not answer, the call comes back to your phone.

Note: You can change the procedure by first starting an enquiry call before call transfer.

Take (pick up own call)

You want to transfer a call from one phone to another without interrupting the connection (for example, from a desk phone to a cordless phone).

The take function can be used to transfer calls between your phones.

Requirement: You are in the one number user concept (see "One number user concept", page 7).

This function must be saved to a configurable function key with Self Service Portal (see chapter "Configuring or deleting a key assignment", page 88).



Picking up your own call (you are in an active call):

Press the function key for *Take*.

→ After a brief moment, you are connected with the caller on another phone.

Starting announcement

You want to speak directly to an internal user or an announcement group via the loudspeaker - where available - without expecting an answer (similar to an intercom). The recipient is alerted to the announcement by two short signal tones. You are immediately unilaterally connected via the loudspeaker.

If the internal user has secured their phone against announcements (configuration see chapter "[Activating protection against call types](#)", page 81), you cannot speak to them using an announcement. You will get the engaged tone.

The announcement function must be saved to a configurable function key with Self Service Portal (see "[Configuring or deleting a key assignment](#)", page 88). You can either configure the function key directly with a designated user or input the call number manually each time.

Announcement to a group:

- The announcement will only be received by phones which both have authorisation to receive announcements and are not in use.
- As soon as a user in a group picks up the handset to answer the announcement, the announcement is ended for all other users in the group.
- If receipt of announcements is not authorised on any of the phones in the announcement group or all the phones are in use, you will hear the busy tone.
- Group announcements are always conducted with a one-sided connection.
- The group number must be entered as two digits.



Start announcement to a user:

Press the function key for <announcement to a user>. Depending on the settings, enter the call number.

→ The user is alerted to the announcement by two short tones on the loudspeaker. The one-sided connection is made, you can talk.



Start announcement to a group:

Press the function key for <announcement to a group>. Depending on the settings, enter the two digit group number.

→ The user group is alerted to the announcement by two short tones on the loudspeaker. The one-sided connection is made, you can talk.

Receiving an announcement

You will be alerted to the announcement with two short signal tones and spoken to directly via the loudspeaker across a one-sided connection. The display shows *Announcement from*.

In order to be able to receive an announcement, your phone must be neither in use nor locked against announcements (configuration see chapter "Activating protection against call types", page 81). To answer the announcement, the following options are available to you:

- You can continue the announcement as a phone call by picking up the handset.
- You can stop the announcement.

Announcement to a group:

- The announcement will only be received by phones which both have authorisation to receive announcements and are not in use.
- As soon as a user in a group picks up the handset to answer the announcement, the announcement is ended for all other users in the group.
- If receipt of announcements is not authorised on any of the phones in the announcement group or all the phones are in use, you will hear the busy tone.
- Group announcements are always conducted with a one-sided connection.



You will be alerted to the announcement with two short signal tones and spoken to directly via the loudspeaker.



Continue an announcement as a phone call:

Pick up the handset.

→ You are on the phone with whoever started the announcement.

Note:

If the announcement was started to the group, all other recipients of the announcement will be excluded.



Stop announcement:

Press the End key.

Recording a call

You want to record an active call with your call partner.

You can record an active conversation if you have been authorized to do so by your system administrator. Your call party can be an internal or an external user. The recordings are made and backed up only as .wave files in your individual e-mail boxes. For this, you must configure at least one e-mail address in the MiVoice Office 400 communication system. You can find a call recording overview in your e-mail box. Contact your system administrator for more information.

You can start recording calls in the following situations:

- during an active call;
- During a conference call (with maximum two participants)
- During an incoming/outgoing call
- in call preparation;
- During dialling with a busy line.

Call recording only starts when the connection is set up. Therefore, no ring-back tones or wait tones are recorded.

Call recording is temporarily interrupted during an enquiry and an e-mail is sent with the recording made up till then. Recording restarts automatically once the call connection with the enquiry call party is set up and/or once the call connection with the first correspondent is restored.

The maximum recording time for each .wave file depends on the system configuration. When the predefined or maximum recording time is reached, the recording stops automatically, the file is sent to your e-mail address and a new recording starts at the same time. Contact your system administrator for more information.

This function must be saved to a configurable function key with Self Service Portal (see chapter ["Configuring or deleting a key assignment"](#), page 88).

- Notes:**
- Recording calls may infringe on your national data protection provisions or be permitted only under certain circumstances. If you intend to use this function notify your call party in advance.
 - You cannot record a conversation involving more than two call parties (enquiry call, conference). The recording is automatically stopped if you park your call party or put him on hold.

Phoning



Recording a call:

Press the function key for *Call recording: start/stop* as soon as you have an incoming/outgoing call or an active call.

→The discussion is recorded and the LED on the function key is switched on.



Stopping the call:

End the recording using also the function key for *Call recording: start/stop*.

→The recording is sent to your e-mail address.

Note: The LED on the function key remains lit while the recording is in progress. The LED starts to flash before the recording reaches its maximum preset duration. Once the maximum duration is reached (or the memory is full), the recording is stopped and the LED goes off.

Activating discreet ring

You do not want to be disturbed by the ring of the phone. You do not, however, want to switch off the phone.

As an alternative to the usual ring, your phone has a discreet ring option. If you have activated discreet ring, the phone only rings once.

This function must be saved to a function key over the Self Service Portal (see "Configuring or deleting a key assignment", page 88).



Activating/deactivating discreet ring:

Press the function key for *Discreet ring on/off*.

→The function is activated/deactivated,  is displayed and the LED on the function key lights up/does not light up.

Activating do not disturb

You do not want to receive any calls for the time being.

With the do not disturb function, you can stop calls being made to you if you are busy in a call or are not otherwise able to take any calls. Your phone does not ring and is set to busy for incoming calls. Your incoming calls are automatically forwarded to a call forwarding destination that has been configured by your system administrator.

Your system administrator must enable this function in the MiVoice Office 400 communication system.

This function must be saved to a function key over the Self Service Portal (see "[Configuring or deleting a key assignment](#)", page 88).

Menu	Description
<i>Do not disturb (busy) on/off</i>	Your phone does not ring and is set to busy for incoming calls.
<i>Do not disturb (forwarding) on/off</i>	Your phone does not ring and is set to busy for incoming calls. Incoming calls are automatically forwarded to a destination that has been configured by your system administrator.



Activating/deactivating do not disturb:

Press the function key for *Do not disturb (busy) on/off* or *Do not disturb (forwarding) on/off*.

→ The function is activated/deactivated,  is displayed and the LED on the function key lights up/does not light up. Your callers hear the busy tone.

Activating intrusion/answering

You want to implement intrusion in a current call.

Intrusion allows you to access a current call between two call parties and listen to their conversation. The call party to which you have initiated intrusion is notified (display and sound signals). Your call party can then respond () to intrusion or reject it.

You can block intrusion; see "[Protecting yourself against calls](#)", page 81.

This function must be saved to a configurable function key with Self Service Portal (see chapter "[Configuring or deleting a key assignment](#)", page 88).

- Notes:**
- Your system administrator must grant you intrusion rights.
 - Intrusion may infringe on your national data protection provisions or be permitted only under certain circumstances. If you intend to use this function, you should therefore notify your call party in advance.



Activating intrusion (the users are talking):

1. Press the function key for *Intrusion*.
2. Enter the call number of the user you want as per the key configuration.

→ The intrusion tone indicates that the function has been activated.

→ If the user has blocked intrusion, connection set up will be cancelled.

**Answering intrusion:**

Press the *Answer* softkey.

→ You will be connected with the user who has activated intrusion; the first call party is put on hold.

**Rejecting intrusion:**

Press the *End* softkey.

→ Intrusion will be rejected; you remain connected to your first call party.

Activating/answering silent intrusion

Silent intrusion (intrusion without prior notice) is a variation of the intrusion function and is used primarily in call centres.

Another user can connect to your active call and listen to the conversation without you or your call party noticing. Unlike with intrusion, there is neither a display nor a sound signal to indicate use of the function.

You cannot reject silent intrusion (but you can block it; see "Protecting yourself against calls", page 81). The microphone of the third user remains off. The third user can, however, enter the conversation at any point by enabling his or her microphone or pressing the intrusion function key.

This function must be saved to a configurable function key with Self Service Portal (see chapter "Configuring or deleting a key assignment", page 88).

Notes:

- Silent intrusion must be enabled in the communication system.
- Your system administrator must grant you silent intrusion rights.
- Silent intrusion may infringe on your national data protection provisions or be permitted only under certain circumstances. If you intend to use this function, you should therefore notify your call party in advance.

**Activating silent intrusion (the users are talking):**

1. Press the function key for *Silent intrusion*.

2. Enter the call number of the user you want as per the key configuration.

→ The function is activated.

→ If the user has blocked intrusion, connection set up will be cancelled.

Answering silent intrusion:

There are neither display nor sound signals on your phone to indicate silent intrusion.

Using further functions

This section explains some more convenient features provided by your phone. All the functions you can save under a configurable key can be found in chapter ["Overview of available functions", page 56.](#)

Activating personal call routing

You want to specify which of your phone shall ring when you receive a call.

You can specify the phone on which a call is signalled with personal call routing.

Your system administrator has set you up multiple phones with the same phone number in the one number user concept (see ["One number user concept", page 7.](#)). The system administrator has also assigned you permission to configure routing in the Self Service Portal. This allows you to set up 5 routings in the Self Service Portal for a range of situations ("Office", "Home Office", "On the road").

You can only answer a call on the phone on which the call is signalled. If you have not configured a call routing, the default setting (all phones are ringing) is used as standard.

The following options are available on your phone for further editing of personal call routing:

Menu	Description
Activate	Activating personal call routing.
Modify	Renaming personal call routing.
Change settings	The personal call routing settings can only be changed by your system administrator or yourself in the Self Service Portal.
Delete	A personal call routing can only be deleted by your system administrator or yourself in the Self Service Portal.



Activating/deactivating personal call routing

Press the function key for [Menu](#) softkey.



Scroll to [Pers. call routing](#) and press the right navigation key to the right.
→ A list of your routings is displayed.



Select the call routing you want and confirm with the [Activate](#) softkey.
→ The selected routing is activated and another is deactivated.

Phoning



Renaming personal call routing:

Press the function key for *Menu* softkey.



Scroll to *Pers. call routing* and press the right navigation key to the right.
→A list of your routings is displayed.



1. Select the call routing you want and confirm with the *Modify* softkey.
2. Enter the name and confirm with the *Select* softkey.

You can also store your individual call routing profiles over the Self Service Portal on a function key and quickly activate or deactivate your desired call routing profile by simply pressing that key.



Press the function key for the desired call routing profile.

→Call routing is activated/deactivated, LED of the function key is switched on/off.

Activating ring alone

You want to specify the phone on which an incoming call is signalled acoustically.

If your system administrator has set up one phone number with several phones (see "One number user concept", page 7), you can use Ring Alone to define on which phone a call is to be signalled acoustically. As soon as you activate Ring Alone on one phone, the ring tone is deactivated for all other phones. An incoming call is signalled in the display of all phones. You can answer the call on each of your phones.

This function must be saved to a configurable function key with Self Service Portal (see chapter "Configuring or deleting a key assignment", page 88).

Note: When you have activated ring alone but deactivated the personal call routing for a phone in parallel, an incoming call is not acoustically but only visually signalled.



Activating/deactivating ring alone

Press the function key for *Ring Alone on/off*.

→Function is activated/deactivated, LED on the function key is switched on/off.

Locking/Unlocking your phone

You need to leave your desk and want to ensure that no-one can alter your phone's settings, look at your private data, or make calls from your phone.

You can lock your phone with a 2 to 10-digit PIN (for more information on the PIN, see "[Changing the PIN](#)", page 79).

This function must be saved to a configurable function key with Self Service Portal (see chapter "[Configuring or deleting a key assignment](#)", page 88).



Activating the phone lock:

Press the function key for [Phone lock on/off](#).

→ The phone is locked and can only be unlocked using your PIN.



Deactivate the phone lock:

1. Press the function key for [Phone lock on/off](#).

2. Enter the PIN and confirm with the [Execute](#) softkey.

3. Unlock the security prompt with the [Unlock](#) softkey.

Note: Use the following function codes (see also User Guide Function Codes user's guide on the [Mitel DocFinder](#)), to activate or deactivate the phone lock for all phones within the one number user concept (see "[One number user concept](#)", page 7):

- Activating the phone lock: Enter the function code *33* <PIN> #
- Deactivate the phone lock: Enter the function code #33* <PIN> #

Acknowledging an appointment call

You can set a call to remind you about an appointment, for example.

[Appointment call](#) is displayed as soon as it is received. Without acknowledgement, the appointment call will ring for 1 minute.

The following options are available: You have to enter or change the time in the Self Service Portal.

Menu	Description
Single appointment call on/off	Activate appointment call on a one-off basis.
Repeat appointment call on/off	Activate appointment call permanently

Phoning

This function must be saved to a configurable function key with Self Service Portal (see chapter "[Configuring or deleting a key assignment](#)", page 88).

- Notes:**
- If you activated forwarding, the appointment call is not forwarded.
 - If you are in call, the appointment call is made as soon as you end the call.



Activates/deactivates appointment call permanently:

Press the function key for [Appointment call](#).

→Function is activated/deactivated, LED on the function key is switched on/off.



Activate single appointment call:

Press the function key for [Appointment call](#).

→Function is activated/deactivated, LED on the function key is switched on/off.



Confirming an appointment call:

Pick up the handset and then hang up immediately.

→The appointment call is confirmed and ended.

Free seating

Free Seating is proposed for workplaces/phones shared by several employees. It allows you to log in on each free free seating phone and to use it with your personal settings as long as your logged in. Ask your system administrator which phones are proposed for free seating.

Log in:

You log in with your call number and your PIN on a free seating phone. Once you are logged in, your personal call lists, phone book and all your other personal settings and Hotkeys are available to you immediately. If your profile contains expansion key modules, but the phone you have logged in to does not, the keys in question will not be available to you. Various sequences of expansion key modules are correctly recognised.

- Notes:**
- You can only log in to a phone if no other user has yet logged in to that phone for free seating purposes.
 - You can only log on once to a Free Seating phone. The moment you log in to another free seating phone, you are automatically logged off the original phone.

Log out:

To free up a phone, you need to log off again. To ensure a phone is not blocked for other users if you forget to log off, your system administrator can set up a logoff process with an automatic time limit:

- After a certain amount of time after login (e.g. 6 hours and 30 min.).
- At a certain time (e.g. 6:30pm)

Notes:

- If no user is currently logged in a free seating phone, possibly only emergency calls are allowed.
- As long as you do not have your own phone or are not logged on to a Free Seating phone, your caller will obtain either the busy signal or be forwarded to a preconfigured destination, depending on the system configuration.

**Log in free seating:**

Press the *Free Seating: Log in/out* softkey.



Enter phone number and PIN and confirm with the **OK** softkey.

→ You are now logged in and can use the free seating phone with your personal settings. The LED on the function key lights up.

Note: The default PIN setting '0000' is not accepted (for more information on the PIN, see chapter "[Changing the PIN](#)", page 79).

**Log out free seating:**

Press the *Free Seating: Log in/out* softkey.

→ The display with the call number is displayed.

Depending on the system configuration enter the PIN and confirm with the **OK** softkey.

→ You are now logged off; the free seating phone is now available again to other users.

Note: You are automatically logged off if your system administrator has set up an automatic logoff process.

Hotline

The hotline is typically used for lift phones, emergency phones, or for baby alarms or hotline in the hospitality/hotel branch.

A user needs help and picks up the handset or presses the Loudspeaker key. The user is automatically routed to the preconfigured hotline destination number stored in the MiVoice Office 400 communication system. The person responsible answers the call and is connected with the user seeking help.

Alarm cancellation delay: Your system administrator can set a delay (0-60 seconds, depending on the Mitel system phone). During this delay the user can enter another call number in order not to trigger a call on the hotline destination number. If the user does not dial another phone number during this predefined time or puts the handset back down again, a connection with the Hotline number is automatically set up. Contact your system administrator for more information.

Using the hotline:

User needs help. He picks up the handset of his phone or presses the Loudspeaker key.

→ A connection with the hotline number is automatically set up after a predefined time without the user having to do anything else.

Overview of available functions

This section contains a list of all the functions you can store under a configurable key via the Self Service Portal. Please note that the selection of functions depends on the selected phone and its authorisation level.

More information on how to save functions to a configurable key using function commands and a function code can be found in the online help for Self Service Portal (see "MiVoice Office 400 Self Service Portal", page 8).

Function	Description
<i>Agent: Log in/out</i>	Log in/out to/from the queue as an agent (control of routing in the queue).
<i>Agent: Wrap-up time log in/out</i>	Activate/deactivate agent wrap-up time.
<i>Agent: Break log in/out</i>	Activate/deactivate agent break.
<i>Show alarm state</i>	Display of the current alarm state.
<i>Picking up a call from a user group</i>	Pick up a call for another user in the user group.
<i>Park call</i>	Keep a call party on hold without keeping a phone line busy. This function is not available in Release 4.0.
<i>Call list: Answered calls</i>	Call list for answered calls.
<i>Call list: Menu</i>	Direct access to the system menu Call list .
<i>Call list: Unanswered calls</i>	Call list for unanswered calls.
<i>Call list: Redial list</i>	Call list for dialled call numbers.

Function	Description
<i>Do not disturb (busy) on/off</i>	Your phone does not ring and is set to busy for incoming calls.
<i>Do not disturb (forwarding) on/off</i>	Your phone does not ring and is set to busy for incoming calls. Incoming calls are automatically forwarded to a destination that has been configured by your system administrator.
<i>Call forw. if busy (CFB) to user on/off</i>	If you are busy, incoming calls will be forwarded to specific destination (user).
<i>Call forw. if busy (CFB) to VM on/off</i>	If you are busy, incoming calls will be forwarded to specific destination (voice mail).
<i>Call forw. (CFU) to user on/off</i>	Incoming calls are automatically forwarded to a specific destination.
<i>Call forw. (CFU) to pager on/off</i>	Incoming calls are automatically forwarded to a specific destination.
<i>Call forw. (CFU) to text message on/off</i>	Incoming calls are automatically forwarded to a specific destination.
<i>Call forw. (CFU) to VM on/off</i>	Incoming calls are automatically forwarded to a specific destination.
<i>Call forwarding menu</i>	Direct access to the Forwarding (see chapter " Call forwarding ", page 63).
<i>Presence menu</i>	Direct access to the Presence (see chapter " Controlling the presence status ", page 61).
<i>Presence profile on/off</i>	Activate/deactivate presence profile. You can select a presence profile (profile number 1-4, see chapter " Controlling the presence status ", page 61).
<i>Intrusion</i>	This function allows you to intrude to a busy user's call with notification (see chapter " Activating intrusion/answering ", page 49).
<i>Welcome announcement on/off</i>	Announcement service for incoming internal and external calls. If you do not answer an external call after a set delay, the user who is calling will obtain an announcement. After the announcement the caller will then hear the ring-back tone again.
<i>Discreet ring on/off</i>	When this function is on, the phone only rings once. For further information, please see " Activating discreet ring ", page 48.

Phoning

Function	Description
<i>Announcement to user</i>	Speak directly to an internal user via the loudspeaker - where available - without them having to first pick up the call. An announcement is a one-sided connection and is indicated by two short signal tones on the recipient phone.
<i>Announcement to group</i>	Speak directly to a group of internal users via the loudspeaker - where available - without them having to first pick up the call. An announcement is a one-sided connection and is indicated by two short signal tones on the recipient phone. Announcement groups will be defined by your system administrator. The group number must be entered as two digits.
<i>Remote maintenance on/off</i>	Allow permanent remote management access on your phone.
<i>Remote maintenance onetime on/off</i>	Allow one-time remote management access on your phone.
<i>Free seating: Log in/out</i>	Log in/out on a free seating phone (see " <u>Free seating</u> ", page 54).
<i>Free configurable</i>	You can use function commands to define a function to suit your personal requirements. A function can consist of one or more function commands, function codes, and the phone number. You can either carry out a function directly or store it under a key.
<i>Start/stop call recording</i>	Record a call. The recordings are stored in your individual e-mailbox only (see " <u>Recording a call</u> ", page 47).
<i>Call transfer</i>	Transfer a call to another user with or without prior notice.
<i>Home Alone on/off</i>	If calls to a user group can only be answered by one user, the user in question can activate Home Alone on the user group. Then if the user is already in a call, all subsequent internal or external calls to the user group obtain a busy tone.
<i>Set up conference</i>	Set up a conference with two call parties.
<i>Empty</i>	The key assignment is configured with an empty function. The key is not overwritten by the following key assignments.
<i>Personal call routing menu</i>	Direct access to the Routing (see chapter " <u>Activating personal call routing</u> ", page 51).
<i>Personal call routing on/off</i>	Activate/deactivate call routing profile (under the one number user concept).

Function	Description
<i>PIN call</i>	Function with OpenCount. Independently from the phone you can make external calls for a fee. The credit may be limited (see chapter " <u>Activating PIN telephony</u> ", page 71).
<i>PIN call rebook</i>	Function with OpenCount. You can charge the charges and the call information of your outgoing and incoming calls to specific projects (see chapter " <u>Activating PIN telephony</u> ", page 71).
<i>Ring Alone on/off</i>	This function lets you specify which of your phones signals incoming calls acoustically (as part of the one-number user concept, see chapter " <u>Activating ring alone</u> ", page 52).
<i>Request a callback</i>	Request a callback if the called party is busy or cannot be reached (see " <u>Requesting a callback</u> ", page 38).
<i>Hide number on/off</i>	Permanently prevents your call number from being displayed to the caller (see chapter " <u>Hide number</u> ", page 40).
<i>Hide number per call</i>	Prevent your call number from being displayed to the caller once (see chapter " <u>Hide number</u> ", page 40).
<i>Call forw. on no reply (CFNR) to user on/off</i>	Incoming calls are automatically forwarded to another destination (user).
<i>Call forw. on no reply (CFNR) to pager on/off</i>	Incoming calls are automatically forwarded to another destination (pager).
<i>Call forw. on no reply (CFNR) to VM on/off</i>	Incoming calls are automatically forwarded to another destination (voice mail).
<i>User group: Log in/out</i>	Log in/out of a user group. In the user group incoming and internal calls are routed to a group of internal destinations according to a preconfigured call distribution.
<i>User group, all: Log in/out</i>	Log in/out of all user groups. In the user group incoming and internal calls are routed to a group of internal destinations according to a preconfigured call distribution.
<i>Switch group x, position 2</i> <i>Switch group x, position 3</i>	This function lets you route calls and functions via switch groups (with two switch positions).
<i>Call forwarding protection on/off</i>	Call forwarding to your phone is not allowed.

Phoning

Function	Description
<i>Control output on/off</i>	You can control external electric equipment or installations using control outputs. For example you can use your phone to open and close electric gates or to switch the lights on or off throughout a building.
<i>Silent intrusion</i>	This intrusion without prior notice function allows you to intrude to a busy user's call without notification (see "Activating/answering silent intrusion" , page 50).
<i>System menu</i>	Access to the MiVoice Office 400 system menu.
<i>Take (pick up own call)</i>	Take a call from your phone on another phone under the one number user concept (see chapter "Take (pick up own call)" , page 44).
<i>Phone lock on/off</i>	Activate/deactivate phone lock. Outgoing calls are not possible, but incoming calls can be answered (see chapter "Locking/Unlocking your phone" , page 53).
<i>Phone book: local</i>	Access to your local phone book. Contacts in the local phone book are stored on the phone only (see chapter "Phone book management" , page 81).
<i>Telefonbuch: System</i>	Direct access to the Directory Lookup system menu . Contacts in the system phone book are integrated in the MiVoice Office 400 communication system (see chapter "Phone book management" , page 81).
<i>Repeat appointment call on/off</i>	Activates/deactivates an appointment call (see chapter "Acknowledging an appointment call" , page 53).
<i>Single appointment call on/off</i>	Activates/deactivates an appointment call on a one-off basis (see chapter "Acknowledging an appointment call" , page 53).
<i>Transparent data</i>	This function takes charge of the transparent exchange of data between the communication server and external applications.
<i>Record voice mail greeting</i>	Records a selected voice mail greeting.
<i>Voice mail greeting on/off</i>	Activates/deactivates a selected voice mail greeting.
<i>Play voice mail greeting</i>	Plays back a selected voice mail greeting.
<i>Voice mail menu</i>	Direct access to the Voice Mail system menu.
<i>Run XML function</i>	Your system administrator creates customer-specific XML services (weather report, stock exchange, etc.) which you can use on your SIP phone.

Organising absences from the desk



This section explains the different options provided by your phone when you want to leave your desk.

The presence function enables you on the one hand to quickly set your personal presence state and hence to route the incoming calls to the destination you want. It also tells you directly whether the user you want is reachable or absent without you having to call him. The information details depend on the type of telephone.

Controlling the presence status

You have a choice of 5 presence profiles for controlling your presence status:

Profile number Presence profile

	0	<i>Available</i> (default)
	1	<i>Absent</i>
	2	<i>Meeting</i>
	3	<i>Busy</i>
	4	<i>Not available</i>

You can call up the presence of the user you want in the following situations.

- in Directory Lookup
- in a call list
- in the presence menu.
- during connection set up

- Notes:**
- Connected CTI applications can affect your presence status. Contact your system administrator for more information.
 - All configuration options for a presence profile can be found in chapter "[Configuring presence profile](#)", page 84.

Operation of the presence status is available via the system menu, a function key (see chapter "[Configuring keys](#)", page 86), or the Self Service Portal (see chapter "[MiVoice Office 400 Self Service Portal](#)", page 8).

Phoning



To deactivate the presence profile:

Press the function key for *Menu* softkey.



Scroll to *Presence* and press the navigation key to the right.



Select the new presence profile and press the *Activate* softkey.



To check a user's presence:

Press the function key for *Menu* softkey.



Scroll to *Presence* and press the navigation key to the right.



1. Press the *Presence?* softkey.

2. Enter the call number and press the *Select* softkey.

Absence information

You wish to give your caller detailed information about your absence.

If you have configured call forwarding to voice mail in your presence profile, you can choose whether the currently active greeting, the global greeting, one of your personal greetings or an absence information should be played back to the caller.

Absence information is available for each presence profile, with the exception of *Available*. Absence information consists of a language-dependent, predefined audio text. The time and/or date are also given as an option. Depending on the voice mail configuration your caller then has immediately the possibility of leaving a message.

Example: "The person you have called is not available until 31st January, at 14:00. Please leave a message after the tone".

The absence information is an integral part of a presence profile. All the relevant configuration possibilities can be found in chapter "[Configuring keys](#)", page 86.

Note: If your Outlook calendar is not synchronised via Mitel Open Interfaces Platform (OIP) with your communication server, you have to manually enter and delete the time and date.



Set up the absence information:

Press the function key for *Menu* softkey.



Scroll to *Presence* and press the navigation key to the right.



Select the presence profile you want and press the *Modify* softkey.



1. Scroll to *Time/date* and press the *Modify* softkey.
2. Make the changes and confirm with the *Select* softkey.
3. Scroll to *Call forwarding* and press the *Modify* softkey.
4. Select *Voice mail* and confirm with the *Select* softkey.
5. Scroll to *Voice mail greeting* and press the *Modify* softkey.
6. Select *Absence information* and confirm with the *Select* softkey.
7. Activate the presence profile.

→ Settings are saved. Your caller hears the selected absence information, followed, if applicable, by time and date.

Call forwarding

You want to leave your desk. Calls for you are to be forwarded to a different destination (e.g. another user, your voice mail).

With call forwarding, you can forward incoming calls directly to a different destination.

- Notes:**
- One call forwarding applies to all connected phones, in one number user concept.
 - Only one call forwarding variant at a time is possible.

The following call forwarding options are available for selection:

Menu	Description
No call forwarding (<i>Call forwarding off</i>)	No CFU is carried out.
Always call forwarding, Incoming calls are automatically forwarded to another CFU (<i>Always (CFU)</i>)	destination.

Menu	Description
Call forwarding if busy, CFB (<i>If busy (CFB)</i>)	Incoming calls are forwarded directly to a different destination if you are busy.
<i>Call Forwarding on No Reply</i>	Incoming calls are automatically forwarded to another destination. Both your own phone and the other destination will then start ringing. The system configuration determines whether or not there is a ringing delay at the other destination. Whoever goes off-hook first, answers the call. Depending on the system configuration, Call Forwarding on No Reply can also be activated when your phone is busy.

Available call forwarding destinations:

Menu	Description
<i>User</i>	Incoming calls are forwarded to an internal user or a call number.
<i>Voice Mail</i>	Incoming calls are forwarded to your voice mail, providing it has been set up by your system administrator. You can use the global greeting or your own greeting (see chapter " <u>Configuring voice mail</u> ", page 82). For further information on voice mail refer to the User Guide Voice Mail Systems on the Mitel DocFinder .

Operation of the call forwarding is available via the system menu, a function key (see chapter "Configuring keys", page 86), or the Self Service Portal (see chapter "MiVoice Office 400 Self Service Portal", page 8).



Activating call forwarding:

Press the function key for *Menu* softkey.



Scroll to *Forwarding* and press the navigation key to the right.



Select the call forwarding variant you want and confirm with the *Modify* softkey.



Select or enter the forwarding destination you want and confirm with the *Select* softkey.

→ The call forwarding is activated.

Note: You can also enter the call number of the user you want manually or find it in a call list.

Deactivate call forwarding:

Call forwarding unconditional can be deactivated via: *Menu* > *Forwarding* > forwarding variant *Forwarding off*.

Operating call lists and voice messages

In this section, you will learn how to use call lists and voice messages which are stored in the MiVoice Office 400 communication system.

Editing options for the call list

The call lists (unanswered/answered calls and redial list) include a maximum of 30 entries each. Missed calls are signalled on the display; the message LED in the call lists key shines red.

The call list display depends on the settings in the MiVoice Office 400 communication system. Contact your system administrator for more information.

The following options are available for further editing of the entries:

Menu	Description
<i>Delete all</i>	Deleting all entries from a specific call list.
<i>Detail</i>	Available detailed information: <ul style="list-style-type: none"> • Call number / name • Call date and time • Number of call attempts • Presence status of the user
<i>Delete</i>	Delete entry. <p>Note: If you delete an entry in the unanswered calls list, then any voice messages for this entry are also deleted. Entries with voice messages that have not been retrieved cannot be deleted.</p>
<i>Dial</i>	Calling a user back.

The call lists can be operated via the call lists key, the system menu or a function key, or via the redial key (see "[Configuring keys](#)", page 86).

More information on call lists can be found in "[Dialling from the call list](#)", page 34.



Options in the call list:

Press the call list key.



1. Scroll to the call list you want and press the *Select* softkey.
2. Scroll through the list until the user you want is displayed.



Calling a user from the call list:

Pick up the handset.

→ The call number of the user is dialed. Once the call has been successfully connected, the user is deleted from the unanswered call list.



Calling up detailed information on an entry:

Select the entry you want and press the *Detail* softkey.



Deleting an entry from the call list:

Select the entry you want and press the *Delete* softkey.



Deleting all entries from the call list:

1. Select an entry and delete all entries with the *Delete all* softkey.
2. Answer the security question with *Yes*.

Editing options for voice messages

Your display shows the symbol for new voice messages and the number of new voice messages. The message LED flashes red slowly.

The following options are available for further editing of the voice messages:

Menu	Description
<i>Detail</i>	Available detailed information: <ul style="list-style-type: none">• Call number / name• Call date and time
<i>Delete</i>	Delete voice message
<i>Forward</i>	Forwards a voice message to another user. You can decide whether to keep a copy of each voice message.
<i>Play</i>	Play voice message.

Notes:

- Depending on the system configuration your system administrator can specify that you are notified by e-mail whenever you receive a new voice message (with the voice message attached). Contact your system administrator for more information.
- To find out how to configure a voice mail, refer to the chapter "[Configuring voice mail](#)" or to the User Guide Voice Mail Systems user guide on the [Mitel DocFinder](#).

Operation of the voice messages is available via the system menu, a function key (see chapter "[Configuring keys](#)", page 86), or the Self Service Portal (see chapter "[MiVoice Office 400 Self Service Portal](#)", page 8).



Options in the voice mail:

Press the function key for *Voicemail*.



Play voice message:

Select the entry you want and press the *Play* softkey.



Calling up detailed information on a voice message:

Select the entry you want and press the *Detail* softkey.



Deleting a voice message:

Select the entry you want and press the *Delete* softkey.



Deleting all voice messages:

Select an entry and delete all entries with the *Delete all* softkey.



Forwarding voice messages:

1. Select the entry you want and press the *Forward* softkey.
2. Enter the call number and press the *Send* softkey.
3. If you wish to keep a copy of the voice message, answer the question with the *Yes* softkey.

Organisation within the team (busy lamp field)

This section explains the different options provided by your phone to communicate in a team.

Using the busy lamp field key

You and your team partners want to be reachable at all times as a team and be able to communicate with one another as quickly as possible.

By pressing a single key you can call a team partner or answer a call for anyone in the team. When a team partner makes a call, the LED for the corresponding busy lamp field key lights up. This tells you when a team partner is busy. The busy lamp field key LED flashes to indicate that the team partner is receiving a call.

You will get the same information by pressing the info key followed by the required busy lamp field key (not possible if the busy lamp field key is saved to a key on a Mitel M680 or Mitel M685 expansion key module).

- Note:**
- More options with the busy lamp field that are not described here can be found with the corresponding function.
 - A busy lamp field can only be saved on function keys T1 to T20 (Mitel 6867 SIP) or function keys T1 to T40 (Mitel 6869 SIP).



Check presence status:

1. Press the info key.
 2. Press the desired busy lamp field key.
- The phone status of the team partner is displayed.

Note:

Press another busy lamp field key to receive additional contact information.



Calling a team partner:

Press the selection key to call the team partner.

To be able to use the busy lamp field key, it must have been configured as such with the call number of the team partner, either by your system administrator or by yourself in the Self Service Portal (see chapter "[Configuring keys](#)", page 86).

Calling a team partner

You want to call a team partner as quickly as possible.



Calling a team partner:

Press the busy lamp field key of the team partner.

- The phone number and possibly the name of the team partner appear on the display. The team partner is called.

Answering a call for a team partner

Your team partner is called. The LED on the busy lamp field key flashes. You know that your team partner is not at his desk at present and therefore decide to answer the call.

You take over the call by pressing the busy lamp field key. As soon as you have answered the call, your team partner is free again.



Answering a call for a team partner:

Pick up the handset as long as the busy lamp field key LED is flashing.

→ You hear the dialling tone.



Press the busy lamp field key.

→ You are through to the person who is calling your team partner.

Line key on a key telephone

This section explains the different options provided by your phone when your system administrator has assigned one of more configurable keys as KT line keys. KT line keys make your phone a key telephone.

A KT line has a number which can be used for internal or external calls. One or usually multiple phones can be connected to this KT line, for example in all employees in a travel agency who work with Europe as a destination. The KT line key belonging to the KT line shows the status of the KT line through an LED and allows you to accept calls which are made to this KT line.

Your phone becomes a key telephone as soon as your system administrator has assigned a KT line to a configurable key. With the configuration of a KT line key, your system administrator will also set up a personal line on which you can make your personal calls.

KT lines are only possible on function keys T1 to T20 (Mitel 6867 SIP) or T1 to T40 (Mitel 6869 SIP).

Answering a call on the KT line key

You are being called on one or more KT line keys. The KT line key(s) flash quickly. You want to answer a call on a KT line key.

If you want to answer a call on another KT line key first, press this KT line key in order to pick up the call. If you pick up the handset without pressing a KT line key, you will be connected to the highest priority KT line.

Phoning



Pick up the handset.

→Connection to the KT line with the highest priority.

Or:

1. Press KT line key.

→KT line is selected.

2. Pick up the handset.

→Connection to the selected KT line.

Initiating a call via a KT line key

You want to make a call via a KT line key.

You can call via any free KT line key. Each KT line key has its own call number. This means that, by phoning, you transmit the call number associated with the active KT line key.

Charges are accrued separately for each KT line key.



Enter the phone number.



Press a free KT line key.

→The LED on the KT line key lights up. KT line is selected.



Pick up the handset.

→The phone number is dialed.

Using functions with OpenCount

OpenCount is a software package used for the call logging management on the communication system. The application can be integrated into your MiVoice Office 400 communication system and enables the logging, the administration, and the analysis of all call and connection data.

If an OpenCount is integrated in your MiVoice Office 400 communication system, the following additional features are also available on your phone.

Activating PIN telephony

The PIN telephony is part of OpenCount. The possible applications of the PIN telephony depend on the area of use, for example in the area of health care and accommodation/hotel:

- Independently from the phone you can make external calls for a fee. The credit may be limited.
- You can charge the charges and the call information of your outgoing and incoming calls to specific projects.

This function must be saved to a configurable function key with Self Service Portal (see chapter "Configuring or deleting a key assignment", page 88).

For further information, please refer to the product-specific OpenCount user guides on our website (www.mitel.com) or contact our system administrator.



Activating/deactivating PIN call:

Press the function key for *PIN call* / *PIN call rebook*.

→Function is activated/deactivated, LED on the function key is switched on/off.

Setting functions by remote control

This section explains how you can alter your phone's settings even if you are not directly at your phone.

You are not at your desk and want to set various functions on your phone from a different phone.

You can activate/deactivate many of your phone's functions by remote control from a different phone.

The remote control is initiated using a special function code. You can then enter the function commands and function codes.



Using remote control from a third-party phone:

1. Enter function code #06.
2. Enter your phone number.
3. Enter your PIN.
4. Enter the function code for activating/deactivating the function you want.



Pick up the handset.
→ You hear the acknowledgement tone.



Put the handset on-hook.
→ The function is activated/deactivated.

Note: The default PIN setting '0000' is not accepted (for more information on the PIN, see chapter "[Changing the PIN](#)", page 79).

Personalizing your phone

These sections explain how to adapt the phone's basic settings to suit your personal requirements.

Configuring the display	74
Configuring the audio properties	75
Configuring general phone settings.	77
Protecting yourself against calls	81
Phone book management	81
Configuring voice mail	82
Configuring presence profile	84
Configuring keys	86

Configuring the display

This section explains how to set display properties.

Setting the display

You may find the display is too bright or too dark.

Display	Description
Home Screen	Setting possibilities for the idle screen. <ul style="list-style-type: none">• Home screen mode Select from two different idle screens.• <i>Screen Saver Timer</i> Time in seconds (0-7200 seconds) for which the back-light should remain activated before the screen saver is displayed.
<i>Brightness</i>	Setting possibilities for the screen brightness. <ul style="list-style-type: none">• <i>Brightness Level</i> Display brightness of level 1 (dark) to 5 (bright).• <i>Brightness Timer</i> Time in seconds (1-7200 seconds) for which the back-light is to remain on in the idle state. After this time the brightness is dimmed. Default value is 600 seconds (10 minutes).



Press the Option key.



Scroll to *Display* and press the selection key.



Setting home screen mode:

Set the desired mode using the horizontal navigation key and confirm with the *Save* softkey.



Setting the duration for the screen saver:

Enter the time in seconds in the input field and confirm with the *Save* softkey.



Setting the brightness:

Set the desired brightness level using the horizontal navigation key and confirm with the *Save* softkey.



Setting the duration for brightness:

Enter the time in seconds in the input field and confirm with the *Save* softkey.

Configuring the audio properties

This section explains how to set audio properties.

Adjusting the volume

You want to change the volume of the ring tone or the handset during a call.

Ring volume: You can adjust the volume in the idle state or when the ring tone sounds. Press and hold the volume down button to switch off the ring tone completely.

Handset volume: You need to set the volume of handset and loudspeaker separately. The new volume will remain saved even after the call is ended.

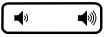

Adjusting the volume (in idle state, during ringing phase/call):

Quieter: Press the  key.

Louder: Press the  key.

Setting the ringing properties

You want to change the way in which your phone rings.

Available settings:

Ring tones	Description
<i>Ring tone</i>	
• <i>Ring tone 1...15</i>	Selection of available ring melodies.
• <i>Silent</i>	If you do not want to be disturbed during a certain time, you can set your phone not to ring with Suppress ring tone.
<i>Tone set</i>	
	Country-specific ring tone settings. This menu is set by your system administrator.



Setting the ring:

Press the Option key.



Scroll to *Audio*.

Personalizing your phone



1. Scroll down to *Ring Tones* using the navigation key and confirm with the selection key.
2. Select the setting you want and confirm with the *Save* softkey.

Note: A list of alarm melodies is available for playback: *Menu > Alarm melodies > Test*.

Setting the audio properties

Using your phone, you can make and answer calls using the handset, headset or handsfree system. The audio settings allow the use of different combinations of these three operation modes in order to achieve maximum flexibility in phone operation. The following options are available for selection:

Audio settings	Description
<i>Audio Mode:</i>	Setting possibilities for headset mode:
• <i>Speaker</i>	The connection is made via loudspeaker. The LED on the loudspeaker key stays lit.
• <i>Headset</i>	The connection is made via handsfree system. The LED on the loudspeaker key lights up. Press the handsfree key to switch to the headset.
• <i>Speaker/Headset</i>	The connection is made via handsfree system. The LED on the loudspeaker key lights up. Press the handsfree key to switch to the headset.
• <i>Headset/Speaker</i>	The connection is made via headset. The LED on the loudspeaker key lights up. Press the handsfree key to switch to handsfree mode.
<i>Headset:</i>	Setting possibilities for your headset:
• <i>Headset Mic Vol</i>	Sets the volume of the headset microphone.
• <i>DHSG</i>	Activate/deactivate DHSG. Phoning using a cordless headset based on the DHSG standard allows you to set up and to end calls from the headset. Ask your dealer which headsets are particularly well suited for this phone. To avoid damages on the phone always disconnect the phone from the mains power first before you install a DHSG headset.

Note: To find out how to make phone calls with the headset, refer to "Using a headset", page 32.



Press the Option key.



Scroll to *Audio*.



Setting the audio mode:

1. Scroll down to *Audio Mode* using the navigation key and confirm with the selection key.
2. Select the mode you want and confirm with the *Save* softkey.



Setting the headset:

1. Scroll down to *Headset* using the navigation key and confirm with the selection key.
2. Select the volume you want or DHSG and confirm with the *Save* softkey.

Configuring general phone settings

This section explains other settings you can make on your phone.

Selecting the language

You wish to select a different user language for your display.

To change both the local user language and the user language of the MiVoice Office 400 communication system, configure the language settings for your phone over the Self Service Portal. For more information about the Self Service Portal, please refer to ["MiVoice Office 400 Self Service Portal", page 8](#).

The language selection is limited to five languages. If the language you want is not available, then your system administrator can upload additional language packs. English is the standard language and is contained in every language pack.

Selecting the time and date

The settings for the time and date are made by your system administrator. The following chapter is thus intended for your system administrator or technician, who will then set the time and date for you.

Personalizing your phone

As system administrator or technician, you can make global settings for the time and date for all Mitel SIP phones in the MiVoice Office 400 communication system. If no NTP time server is entered in the communication system, then you can also make these settings over the phone. Available settings:

Setting	Description
<i>Settings</i>	
• <i>Time format</i>	12-hour or 24-hour clock format.
• <i>Daylight savings</i>	<ul style="list-style-type: none">• List of available summer time formats.<ul style="list-style-type: none">– Off– 30min summertime– 1h summertime– Automatic
• <i>Date format</i>	List of available date formats.
<i>Time zone</i>	List of available global time zones.
<i>Set Date and Time</i>	Set the time and date manually or select <i>Use Network Time</i> and make the settings for the time server.
• <i>Use network time</i>	The settings for the time and date are controlled by the communication system. The time/date are shown on the display when in the idle state.
• <i>Time server 1-3</i>	Setting menu for the IP address or domain name of the time server. If a valid time server is set, then the phone synchronises the displayed time with the specified configuration server. The phone adopts the time from time server 1. If this is not configured or cannot be reached, then the phone queries first time server 2 and then 3.
• <i>Time</i>	Setting menu for the time. The time/date are shown on the display when in the idle state.
• <i>Set date</i>	Setting menu for the date. The time/date are shown on the display when in the idle state.



Press the Option key.



Scroll to *Time/date*.



Settings:

1. Scroll down to [Settings](#) using the navigation key and confirm with the selection key.
2. Select the setting you want and confirm with the [Save](#) softkey.



Setting the time zone:

1. Scroll down to [Time Zone](#) using the navigation key and confirm with the selection key.
2. Select the setting you want and confirm with the [Save](#) softkey.



Set Date and Time:

1. Scroll down to [Set Date and Time](#) using the navigation key and confirm with the selection key.
2. Select the setting you want and confirm with the [Save](#) softkey.

Using Live Dialpad (single-digit dialling)

Activates or deactivates the Live Dialpad. This local function is not supported by the MiVoice Office 400 communication system.

Using speed dial edit

Menu for configuration of the keypad speed dial. This local function is not supported by the MiVoice Office 400 communication system.

Changing the PIN

You want to change the PIN used to lock/unlock your phone and protect your phone settings (more information about locking/unlocking your phone can be found in chapter ["Locking/Unlocking your phone"](#)).

The digit combination "0000" is set as default. You can select any 2 to 8-digit combination for your new PIN. The PIN on your phone is changed using the Self Service Portal. For more information about the Self Service Portal, please refer to ["MiVoice Office 400 Self Service Portal"](#), page 8.

- Notes:**
- The PIN that you have changed locally on your phone cannot be displayed or overwritten over the Self Service Portal.
 - If you change your user PIN in the Self Service Portal, it will be valid for all your phones in the one number user concept (see ["One number user concept"](#), page 7).

Enter the display text for the idle state

You want to change the text displayed by your phone in the idle state.

The display text shown in the idle state on your phone is configured using the Self Service Portal. For more information about the Self Service Portal, please refer to "[MiVoice Office 400 Self Service Portal](#)", page 8.

Local IP settings

The specific data for your phone, such as IP address or memory, is stored in the option key menu > or *Menu* > *Information*. The input of this data is password-protected; it can therefore only be carried out by your system administrator. You can however call up the data.



Calling up the phone status:

Press the Option key.



Scroll to *Status* and confirm with the selection key.

→Settings are displayed.



Calling up the system menu:

Press the function key for *Menu*.



Scroll to *Information* and press the navigation key to the right.

→Settings are displayed.

Restarting the phone

You want to restart your phone. You have to restart your phone after the following actions:

- Uploading a new language pack or updating a newly selected language.
- Uploading new phone software.
- Confirming new settings.



Press the Option key.



1. Scroll to *Restart* and confirm with the selection key.

2. Answer the security question with *Yes*.

→The phone is restarted.

Protecting yourself against calls

The protection function helps to protect yourself against other users applying telephony features on you via menu guidance or using function codes.

Activating protection against call types

You want to protect yourself against certain types of call. You can protect yourself from the following types of call:

- Call waiting
- Intrusion
- Call forwarding
- Announcement
- Fast take
- Remote control

Protection for these call types is configured using the Self Service Portal. For more information about the Self Service Portal, please refer to ["MiVoice Office 400 Self Service Portal", page 8.](#)

Phone book management

This section includes important information on your phone books.

Selection

If your phone is connected to an MiVoice Office 400 communications system, then the following phone books can be selected:

System phone book

The system phone book contains the contacts of the users on the MiVoice Office 400 communication system and your private contacts, to which only you have access. It is integrated into the MiVoice Office 400 communication system by your system administrator.

With the help of quickdial and dialling by name in the system phone book, you can search for and call both a contact in the MiVoice Office 400 communication system and in your private phone book.

Personalizing your phone

Local phone book:

Aside from the system phone book, your phone also has a local phone book. This can be assigned to a function key.

The local phone book is not supported by the MiVoice Office 400 communication system. This implies that contacts saved in this local phone book are only available on your Mitel SIP phone. The search function in the system phone book (quickdial and dialling by name) does not search in the local phone book.

Private contacts:

We recommend using the following products to manage your private contacts:

- Self Service Portal (see chapter "[MiVoice Office 400 Self Service Portal](#)", page 8).
- Mitel OfficeSuite
- External directories, such as Microsoft Exchange (provided your MiVoice Office 400 communication system is synchronised with external directories).

Notes: Searching using the phone books is explained in more detail under "[Dialling from the phone book \(directory lookup\)](#)", page 33.

Configuring voice mail

This section explains how to set your voice mail.

Managing personal voice mail greeting

In line with the system configuration, you have the option of recording up to 3 different greetings (e.g. for absences or holidays). Give each greeting a relevant name. Depending on the system configuration a caller may or may not be able to leave a message (for the symbols see mode).

If no personal greeting is activated or if none is available, the global greeting is activated automatically, provided it has been recorded. For further information on voice mail refer to your system administrator or the User Guide Voice Mail Systems on the [Mitel DocFinder](#).

The following options are available for further editing of your voice mail greetings:

Menu	Description
<i>Record</i>	Record voice mail greeting.
<i>Select</i>	Activating the voice mail greeting.
<i>Edit</i>	Renaming the voice mail greeting.
<i>Mode:</i>	Selecting the mode: <ul style="list-style-type: none"> • <i>Recording allowed</i> Caller can leave a message. • <i>Recording not allowed</i> Caller cannot leave a message.
<i>Play</i>	Play voice mail greeting

Operation of voice mail is available via the system menu, a function key (see chapter "Configuring keys", page 86), or the Self Service Portal (see chapter "MiVoice Office 400 Self Service Portal", page 8).



Press the function key for *Voice mail*.



Press the *Settings* softkey.



Renaming the voice mail greeting:

1. Select the greeting you want and press the *Edit* softkey.
2. Enter the name and confirm with the *Select* softkey.



Recording voice mail greeting:

1. Select the greeting you want and press the *Record* softkey.
2. Pick up the handset and record your own personal greeting.
3. Stop the recording using the *Done* softkey.



Playing voice mail greeting:

1. Select the greeting you want and press the *Play* softkey.
2. You can monitor your personal greeting text and re-record it if necessary.



Selecting the mode:

1. Select the greeting you want and press the *Mode* softkey.
2. Select the mode you want and confirm with the *Select* softkey.



Activating the voice mail greeting:

Select the greeting you want and press the *Select* softkey.

Configuring presence profile

Do you want to manage your incoming calls taking your current presence status into account (see chapter ["Organising absences from the desk"](#), page 61).

You have a choice of 5 presence profiles for controlling your presence status: [Available](#), [Absent](#), [Meeting](#), [Busy](#), [Not available](#). Presence profiles contain action commands that are executed when the presence status is activated. This may be a call forwarding to a voice mail and/or a predefined personal call routing.

For each of these presence profiles you can make the following settings:

Menu	Description
Description	Type in the text to be displayed to other users as detailed information for your presence status (e.g.: "Meeting until 4 pm."). You can also leave this input field blank.
Time/Date	Type in the time and/or date of your absence: This information is played to your caller, providing you selected the Absence information setting for call forwarding to voice mail. You can also leave this input field blank.
Personal call routing:	Specify the phones on which a call is to be signalled (see "Activating personal call routing" , page 51).
<ul style="list-style-type: none">• Keep settings as is• Routing ID <1...5>	<p>Calls are routed according to your settings.</p> <p>Your personal call routing number.</p>
Call forwarding:	Specify the phones on which a call is to be signalled (see "Activating personal call routing" , page 51).
<ul style="list-style-type: none">• Keep settings as is• Forwarding off	<p>Calls are routed according to your settings.</p> <p>Any configured call forwarding operation is deleted.</p>
Note:	You can specify in the Self Service Portal whether you want the same or a different forwarding destination for external and internal calls. The call number of the external call forwarding destination is then always shown on your phone display unless the external forwarding destination is No forwarding .
<ul style="list-style-type: none">• User• Voice Mail	<p>A call is channelled to the defined forwarding destination.</p> <p>A call is forwarded to voice mail. The greeting to be played can be configured with voice mail greeting.</p>
Voice mail greeting:	Activate the greeting you want.

Menu	Description
• Keep settings as is	Your currently defined greeting is used.
• Absence information	Your caller is given an absence information (as well as time and date, if this has been configured as such in the presence profile). This setting is not available in the Available presence profile. More information can be found under " Absence information ", page 62.
• Default greeting	The global greeting is played back to your caller.
• Personal greeting	<ul style="list-style-type: none">• If you renamed your personal greeting, your greeting name is displayed here. Your caller obtains one of the personal greetings.• The time and date are never played in the global greeting and personal greetings.

Operation of the presence settings is available via the system menu, a function key (see chapter "[Configuring keys](#)", page 86), or the Self Service Portal (see chapter "[MiVoice Office 400 Self Service Portal](#)", page 8).



Press the function key for [Menu](#).



Scroll to [Presence](#) and confirm with the selection key.



Changing the presence profile:

1. Select the presence profile you want and press the [Modify](#) softkey.
2. Select the setting you want and press the [Modify](#) softkey.
3. Make the changes and confirm with the [Select](#) softkey.

Configuring keys

This section explains how to assign call numbers, functions and busy lamp fields to a key.

Available keys

You can select the following keys for configuration purposes:

Key	Description
Softkey	You can store call numbers or functions on a softkey.
Configurable key	You can store call numbers, functions or busy lamp fields on a configurable key.
Line key	Line keys are set by your system administrator. For more information on line keys, refer to chapter " Dialling with the line key ", page 36.

You can assign each key a specific action type so that you can trigger a particular action by simply pressing that key. The following choice is available:

Action type	Designation	Description
<i>Call number</i>	Number key	Configure a key with a call number and name
<i>Function</i>	Function key	Configure a key with a function in order to run or activate/deactivate a function.
<i>Busy lamp field</i>	Team key ¹⁾	Configure a key with your team partner's call numbers. Team keys are only possible on function keys T1 to T20 (Mitel 6867 SIP) or T1 to T40 (Mitel 6869 SIP).

Action type	Designation	Description
<i>KT line</i>	Line key	<p>A line key has a call number which can be used for internal or external calls. In general, multiple phones can be connected to this line. Your phone becomes a key telephone as soon as your system administrator has assigned the first KT line to a configurable key. You can make the personal settings for the KT line in the Self Service Portal.</p> <p>KT lines are only possible on function keys T1 to T20 (Mitel 6867 SIP) or T1 to T40 (Mitel 6869 SIP). For more information on KT line keys, please refer to "Line key on a key telephone", page 69.</p>
<i>Operator</i>	Operator phone	<p>An operator phone has a line key with a call number on which both external and internal incoming calls can be connected. Your phone becomes an operator phone as soon as your system administrator has assigned the first line key on your phone. You can make the personal settings for the operator phone in the Self Service Portal.</p> <p>Lines for operator phones are only possible on function keys T1 to T20 (Mitel 6867 SIP) or T1 to T40 (Mitel 6869 SIP). For more information on KT line keys, please refer to "Line key on a key telephone", page 69.</p>
<i>Personal line</i>	Personal call key	<p>Personal line on key telephones and operator phones on which you can make personal calls. The personal line is created automatically as soon as your system administrator has assigned a key on your phone as a KT line or operator.</p>

Note: Your phone can be either a key telephone or an operator phone.

¹⁾ The audio features of a busy lamp field can be configured in the Self Service Portal (see ["MiVoice Office 400 Self Service Portal", page 8](#)).

Personalizing your phone

Removable key caps:

You can change the position of certain function keys or switch them with other functions. You can swap the existing key caps or fit keys with the additional key caps supplied. The key configuration must have been made either by your system administrator or by yourself in the Self Service Portal (see chapter "[MiVoice Office 400 Self Service Portal](#)", page 8).

Function key	Removable key cap	Additional key cap (included in the scope of delivery)
Call lists key	yes	
Conference key	yes (Mitel 6867 SIP only) ¹⁾	
Line key L1	yes	
Line key L2	yes	
Line key L3		yes
Line key L4		yes
Phone book key	yes (Mitel 6867 SIP only) ¹⁾	
Forwarding button		yes
Voice mail key		yes
Redial key	yes	
Deflect key	yes (Mitel 6867 SIP only)	yes

¹⁾ Key can only be configured as a number or function key.

Configuring or deleting a key assignment

You want to configure a configurable key with a call number, function or busy lamp field, or to delete the key configuration.

Keys must be configured by your system administrator or by yourself in the Self Service Portal (see "[MiVoice Office 400 Self Service Portal](#)", page 8). An overview of the available functions can be found in the chapter "[Overview of available functions](#)", page 56.

Note: A key that you have configured locally on your phone cannot be displayed or overwritten over the Self Service Portal.

Operating a key with key configuration

A key with a key configuration can be operated as follows:



Calling the call number of a number key:

Press the key for <Call number>.

→The contact for this call number is called.



Activating/deactivating the function:

Press the function key for <Function>.

→Function is activated/deactivated, LED on the function key is switched on/off.



Calling the call number of a busy lamp field key:

Press the function key for <Busy lamp field>.

→The call number of the busy lamp field key is called.

Product and safety information

The product and document information is available here. You will also find notes on safety, data protection and legal notes. Please read through this product and safety information carefully.

Safety information	91
Product information	91
Data protection	93
Limited Warranty (Australia only)	93

Safety information

The safety information can be found in the chapter "Safety information", Seite 3.

Product information

Purpose and function

This product is part of the MiVoice Office 400 communication solution.

MiVoice Office 400 is an open, modular and comprehensive communication solution for the business sector with several communication servers of different output and expansion capacity, a comprehensive telephone portfolio and a multitude of expansions. They include an application server for Unified Communications and multimedia services, an FMC (Fixed Mobile Conversion) controller for integrating mobile phones, an open interface for application developers and a multitude of expansion cards and modules.

The business communication solution with all its components was developed to cover in full the communication requirements of businesses and organisations, in a way that is both easy to use and maintenance-friendly. The individual products and components are coordinated and must not be used for other purposes or replaced by third-party products or components (unless it is to connect other approved networks, applications and telephones to the interfaces certified specially for that purpose).

User information

Document portal: www.mitel.com/docfinder.

© The information, graphics and layouts featured in the user information are subject to copyright and may not be duplicated, presented or processed without the written consent of Mitel Schweiz AG.

Your product is supplied with a Quick User's Guide, safety information and, where applicable, with other product-specific information. These and all other user documents are available for download from the [Mitel DocFinder](#)

Product and safety information

as individual documents or as documentation set. It is your responsibility to keep up to date with the scope of functions, the proper use and the operation of your product.

- Make sure you have all the user documents required to operate your product efficiently and correctly.
- Make sure that the versions of the user documents comply with the software level of the MiVoice Office 400 products used and that you have the latest editions.
- Always read the user documents first before you put your product into operation.
- Store the user information within easy reach and refer to it whenever uncertainties arise in connection with the use of the product.
- When handing over your product to others, make sure you enclose the relevant user information.

Trademarks

Mitel® is a registered trademark of Mitel Networks Corporation.

All other trademarks, product names and logos are trademarks or registered trademarks of their respective proprietors.

The designations used in this manual for software and hardware are registered trademarks and are thus subject to the relevant regulations.

Exclusion of liability

This exclusion of liability is not valid for Australia. For more information about exclusion of liability in Australia refer to chapter "Limited Warranty (Australia only)", Seite 93.

All parts and components of the MiVoice Office 400 communication solution are manufactured in accordance with ISO 9001 quality guidelines. The relevant user information has been compiled with the utmost care. The functions of the MiVoice Office 400 products have been tested and approved after comprehensive conformity tests. Nonetheless, errors cannot be entirely excluded. The manufacturers shall not be liable for any direct or indirect damage that may be caused by incorrect handling, improper use, or any other faulty behaviour. Potential hazards are mentioned in the relevant places in the user information. Liability for loss of profit shall be excluded in any case.

About Mitel

Mitel® (Nasdaq:MITL) (TSX:MNW) is a global leader in business communications that easily connect employees, partners and customers - anywhere, anytime and over any device, for the smallest business to the largest enterprise. Mitel offers customers maximum choice with one of the industry's broadest portfolios and the best path to the cloud. With more than US\$1 billion in combined annual revenue, 60 million customers worldwide, and #1 market share in Western Europe, Mitel is a clear market leader in business communications. For more information, go to www.mitel.com.

Data protection

Protection against listening in and recording

The MiVoice Office 400 communication solution comprises features which allow calls to be monitored and recorded without the call parties noticing. Please note that these features can only be used in compliance with national data protection provisions.

Limited Warranty (Australia only)

The following limited warranty agreement is valid for Australia only.

The benefits under the Mitel Limited Warranty below are in addition to other rights and remedies to which you may be entitled under a law in relation to the products.

In addition to all rights and remedies to which you may be entitled under the Competition and Consumer Act 2010 (Commonwealth) and any other relevant legislation, Mitel warrants this product against defects and malfunctions in accordance with Mitel's authorized, written functional specification relating to such products during a one (1) year period from the date of original purchase ("Warranty Period"). If there is a defect or malfunction, Mitel shall, at its option, and as the exclusive remedy under this limited warranty, either repair or replace the product at no charge, if returned within the warranty period.

Repair Notice

To the extent that the product contains user-generated data, you should be aware that repair of the goods may result in loss of the data. Goods presented for repair may be replaced by refurbished goods of the same type rather than being repaired. Refurbished parts may be used to repair the goods. If it is necessary to replace the product under this limited warranty, it may be replaced with a refurbished product of the same design and colour.

If it should become necessary to repair or replace a defective or malfunctioning product under this warranty, the provisions of this warranty shall apply to the repaired or replaced product until the expiration of ninety (90) days from the date of pick up, or the date of shipment to you, of the repaired or replacement product, or until the end of the original warranty period, whichever is later. Proof of the original purchase date is to be provided with all products returned for warranty repairs.

Exclusions

Mitel does not warrant its products to be compatible with the equipment of any particular telephone company. This warranty does not extend to damage to products resulting from improper installation or operation, alteration, accident, neglect, abuse, misuse, fire or natural causes such as storms or floods, after the product is in your possession. Mitel will not accept liability for any damages and/or long distance charges, which result from unauthorized and/or unlawful use.

To the extent permitted by law, Mitel shall not be liable for any incidental damages, including, but not limited to, loss, damage or expense directly or indirectly arising from your use of or inability to use this product, either separately or in combination with other equipment. This paragraph, however, is not intended to have the effect of excluding, restricting or modifying the application of all or any of the provisions of Part 5-4 of Schedule 2 to the Competition and Consumer Act 2010 (the ACL), the exercise of a right conferred by such a provision or any liability of Mitel in relation to a failure to comply with a guarantee that applies under Division 1 of Part 3-2 of the ACL to a supply of goods or services.

This express warranty sets forth the entire liability and obligations of Mitel with respect to breach of this express warranty and is in lieu of all other express or implied warranties other than those conferred by a law whose application cannot be excluded, restricted or modified. Our goods come with guarantees that cannot be excluded under the Australian Consumer Law. You are entitled to a replacement or refund for a major failure and for

compensation for any other reasonably foreseeable loss or damage. You are also entitled to have the goods repaired or replaced if the goods fail to be of acceptable quality and the failure does not amount to a major failure.

Warranty Repair Services

Procedure: Should the product fail during the warranty period and you wish to make a claim under this express warranty, please contact the Mitel authorized reseller who sold you this product (details as per the invoice) and present proof of purchase. You will be responsible for shipping charges, if any.

Limitation of liability for products not of a kind ordinarily acquired for personal, domestic or household use or consumption (e.g. goods/services ordinarily supplied for business-use).

Limitation of liability

- 1.1 To the extent permitted by law and subject to clause 1.2 below, the liability of Mitel to you for any non-compliance with a statutory guarantee or loss or damage arising out of or in connection with the supply of goods or services (whether for tort (including negligence), statute, custom, law or on any other basis) is limited to:
 - a) in the case of services:
 - i) the resupply of the services; or
 - ii) the payment of the cost of resupply; and
 - b) in the case of goods:
 - i) the replacement of the goods or the supply of equivalent goods; or
 - ii) the repair of the goods; or
 - iii) the payment of the cost of replacing the goods or of acquiring equivalent goods; or
 - iv) the payment of the cost of having the goods repaired.
- 1.2 Clause 1.1 is not intended to have the effect of excluding, restricting or modifying:
 - a) the application of all or any of the provisions of Part 5-4 of Schedule 2 to the Competition and Consumer Act 2010 (the ACL); or
 - b) the exercise of a right conferred by such a provision; or
 - c) any liability of Mitel in relation to a failure to comply with a guarantee that applies under Division 1 of Part 3-2 of the ACL to a supply of goods or services.

After Warranty Service

Mitel offers ongoing repair and support for this product. If you are not otherwise entitled to a remedy for a failure to comply with a guarantee that cannot be excluded under the Australian Consumer Law, this service provides repair or replacement of your Mitel product, at Mitel's option, for a fixed charge. You are responsible for all shipping charges. For further information and shipping instructions contact:

Manufacturer:

Mitel South Pacific Pty Ltd ("Mitel")
Level 1, 219 Castlereagh Street
Sydney, NSW2000, Australia
Phone: +61 2 9023 9500

Note:

Repairs to this product may be made only by the manufacturer and its authorized agents, or by others who are legally authorized. Unauthorized repair will void this express warranty.

Index

A

Absence information, setting	62
Accessories <i>see</i> : Safety information	3
Advanced search	33
Alarm melodies	76
Alphanumeric keyboard	19
Ambient conditions <i>see</i> : Safety information	3
Announcement:	
– Announcement to group	45
– receiving	46
– starting	45
Appointment call, acknowledging:	
– Repeat appointment call	53
– Single appointment call	53
Audio properties, setting	76

B

Brokering	41
Busy lamp field	67

C

Call Forwarding on No Reply	63
Call forwarding:	
– always (CFU)	63
– if busy (CFB)	63
– on no reply (CNFR)	63
– to voice mail	63
Call list:	
– calling a contact	65
– deleting an entry	65
– detailed information	65
– of answered calls	34
– of dialled call numbers	34
– of unanswered calls	34

Call logging management <i>see</i> :	
OpenCount	71
Call partners, holding <i>see</i> : Hold	40
Call routing profile	52
Call routing, activating	51
Call transfer:	
– with prior notice	43
– without prior notice	43
Callback:	
– answering	39
– requesting	38
Calls, forwarding <i>see</i> : Call forwarding	63
Calls:	
– answering	30
– answering for a team partner	68
– ending	30
– initiating	32
– making	30
– private call with PIN	38
– recording	47
– rejecting	30
– take (pick up own call)	44
– with another Mitel phone	37
CLIR <i>see</i> : Hide number	40
Conference call, making	42
Configurable key, using	18
Connect <i>see</i> : Call transfer	43
Connections <i>see</i> : Safety information	3
Cost control <i>see</i> : Safety information	3

D

Data protection	93
Date, setting	77
Defect <i>see</i> : Call transfer	43
DHSG standard audio features	76
Dial by name	33

Dialling:	
– by name	33
– from call list of answered calls	34
– from call list of unanswered calls	34
– from phone books	33
– with configurable key	35
– with line key	36
– with phone number	32
– with redial list	34
Dialpad <i>see: Live Dialpad, using</i>	79
Directories, managing <i>see: Phone book</i>	81
Directory Lookup	33
Discreet ring, activating	48
Display symbols	15
Display text for idle state	80
Disposal <i>see: Safety information</i>	3
Do not disturb, activating:	
– busy	48
– forward	48
Document information	4

E

Enquiry call during a call	41
Exclusion of liability	92

F

Fast take	7
Forwarding <i>see: Call forwarding</i>	63
Free seating	54
Function	91
Function key configuration (default setting)	18
Function selection for configurable key	56

G

Group announcement <i>see: Announcement</i>	45
---	----

H

Handset volume <i>see: Volume</i>	75
Handsfree	31

Headset:	
– operation	76
– using a	32
Hide number:	
– per call	40
– permanent	40
Hold	40
Hotline	55

I

Icons <i>see Display symbols</i>	15
Information <i>see: IP settings</i>	80
Intrusion	49
IP settings	80

K

Key telephone	69
Key:	
– assignment, configuring	88
– assignment, deleting	88
– designations	10
– legend	10
– selection	86
KT line key	69
KT line:	
– answering call on KT line key	69
– Calling with KT line key	70

L

Labels:	
– attaching	28
– printing	28
Language, selecting	77
LED	20
Legend <i>see Key legend</i>	10
Limited Warranty (Australia only)	93
Line key	36, 69
Listening <i>see: Data protection</i>	93
Live Dialpad, using	79
Local IP settings <i>see: IP settings</i>	80
Local phone book <i>see: Phone book</i>	81

Locking *see*: Phone lock 53

M

Magnetic keypad *see* Mitel K680 24
Maintenance *see*: Safety information 3
Making calls *see also*: Calls, initiating 32
Making calls:
– in hands-free mode 30
– in handsfree mode 31
– with headset 32
Menu guidance *see*: Operation 17
Message LED *see*: LED 20
Metal objects *see*: Safety information 3
Microphone, muting 31
Mitel K680 24
Mitel K680 keypad 24
Mitel M680 22
Mitel M680 expansion key module 22
Mitel M685 23
Mitel M685 expansion key module 23
MiVoice Office 400 Self Service Portal 8
Mute 31

N

Navigation key, using 17

O

One number user concept 7
Open listening 30
OpenCount 71
Operating elements 10
Operation 17
Options List 13

P

Personal call routing *see*: Call routing,
activating 51
Phone book:
– external phone book 33
– local phone book 81

– system phone book 81
Phone lock 53
Phone status 80
Phone, activating 37
PIN:
– changing 79
– telephony, activating 71
Power supply *see*: Safety information 3
Presence profile:
– configuring 84
– selection 61
Presence status, controlling 61
Product information 91
Protection against call types 81

Q

Quickdial 33

R

Recording *see*: Calls, recording 47
Recording *see*: Data protection 93
Redial list 34
Remote control 72
Restart phone 80
Ring Alone, activating 52
Ring tones 75
Ring volume *see*: Volume 75
Ringing properties, setting 75

S

Safety information 3
Self Service Portal 8
Silent intrusion 50
Silent *see*: Ringing properties 75
Singel-digit dialling *see*: Live Dialpad,
using 79
Softkey, using 17
Speed dial edit, using 79
Standard key configuration 18

Switching between 2 call parties	
<i>see</i> : Brokering	41
Symbols <i>see</i> Display symbols	15
System menu	17
System phone book <i>see</i> : Phone book	81

T

Take	44
Team organisation <i>see</i> : Busy lamp field	67
Team partner:	
– answering a call	68
– calling	68
Text:	
– correcting	20
– entering	20
Time, setting	77
Trademarks	92

U

Unlocking <i>see</i> : Phone lock	53
User information	91

V

Voice mail <i>see also</i> : Voice message	66
Voice message:	
– deflecting	66
– deleting	66
– detailed information	66
– playing	66
Vicemail:	
– configuring	82
– greeting, managing	82
Volume	75



MITEL SCHWEIZ AG, SOLOTHURN

hereby declares that the MiVoice Office 400 products

- conform to the basic requirements and other relevant stipulations of Directive 1999/5/EC.
- are manufactured in conformity with RoHS according to 2011/65/EU.

The product-specific declarations of conformity can be found on the Mitel document portal:

www.mitel.com/docfinder.